

PSTricks:

PostScript macros for Generic TeX.

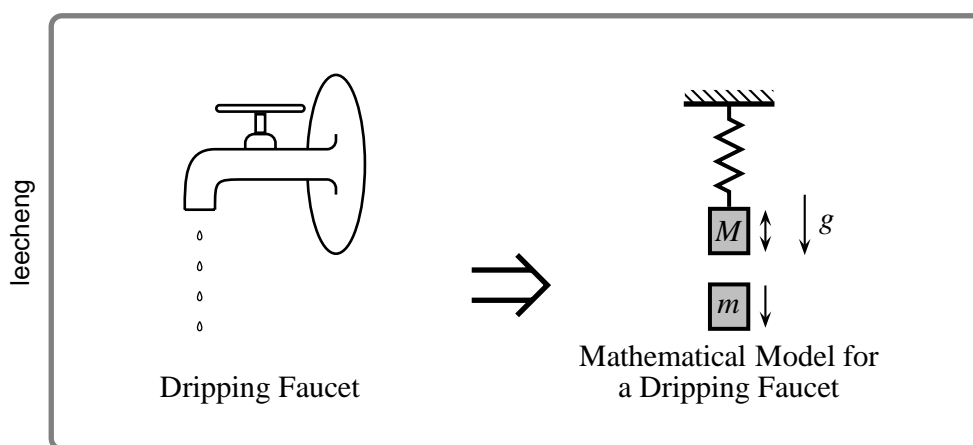

User's Guide

Timothy Van Zandt

12 March 1993
Version 0.93a

Author's address:
Department of Economics, Princeton University,
Princeton, NJ 08544-1021, USA. Internet: tvz@Princeton.EDU

Contents

Welcome to PStricks	1
Part I The Essentials	3
1 Arguments and delimiters	3
2 Color	4
3 Setting graphics parameters	5
4 Dimensions, coordinates and angles	7
5 Basic graphics parameters	8
Part II Basic graphics objects	10
6 Lines and polygons	10
7 Arcs, circles and ellipses	11
8 Curves	13
9 Dots	15
10 Grids	17
11 Plots	19
Part III More graphics parameters	24
12 Coordinate systems	24
13 Line styles	24
14 Fill styles	27
15 Arrowheads and such	28
16 Custom styles	31
Part IV Custom graphics	32
17 The basics	32
18 Parameters	32
19 Graphics objects	33

20	Safe tricks	36
21	Pretty safe tricks	39
22	For hackers only	39
	Part V Picture Tools	41
23	Pictures	41
24	Placing and rotating whatever	42
25	Repetition	46
26	Axes	47
	Part VI Text Tricks	52
27	Framed boxes	52
28	Clipping	54
29	Rotation and scaling boxes	55
	Part VII Nodes and Node Connections	58
30	Nodes	59
31	Node connections	60
32	Attaching labels to node connections	66
	Part VIII Special Tricks	70
33	Coils and zigzags	70
34	Special coordinates	71
35	Overlays	73
36	The gradient fill style	74
37	Adding color to tables	75
38	Typesetting text along a path	76
39	Stroking and filling character paths	77
40	Importing EPS files	78

41	Exporting EPS files	79
	Help	82
A	Boxes	82
B	Tips and More Tricks	85
C	Including PostScript code	86
D	Troubleshooting	87

Welcome to PSTricks

PSTricks is a collection of PostScript-based \TeX macros that is compatible with most \TeX macro packages, including Plain \TeX , \LaTeX , AMSTeX , and $\text{AMS-}\LaTeX$. PSTricks gives you color, graphics, rotation, trees and overlays. PSTricks puts the icing (PostScript) on your cake (\TeX)!

To install PSTricks, follow the instructions in the file `read-me.pst` that comes with the PSTricks package. Even if PSTricks has already been installed for you, give `read-me.pst` a look over.

This *User's Guide* verges on being a reference manual, meaning that it is not designed to be read linearly. Here is a recommended strategy: Finish reading this brief overview of the features in PSTricks. Then thumb through the entire *User's Guide* to get your own overview. Return to Part I (Essentials) and read it carefully. Refer to the remaining sections as the need arises.

When you cannot figure out how to do something or when trouble arises, check out the appendices (Help). You just might be lucky enough to find a solution. There is also a \LaTeX file `samples.pst` of samples that is distributed with PSTricks. Look to this file for further inspiration.

This documentation is written with \LaTeX . Some examples use \LaTeX specific constructs and some don't. However, there is nothing \LaTeX specific about any of the macros, nor is there anything that does not work with \LaTeX . This package has been tested with Plain \TeX , \LaTeX , $\text{AMS-}\LaTeX$ and AMSTeX , and should work with other \TeX macro packages as well.



The main macro file is `pstricks.tex/pstricks.sty`. Each of the PSTricks macro files comes with a `.tex` extension and a `.sty` extension; these are equivalent, but the `.sty` extension means that you can include the file name as a \LaTeX document style option.

There are numerous supplementary macro files. A file, like the one above and the left, is used in this *User's Guide* to remind you that you must input a file before using the macros it contains.

For most PSTricks macros, even if you misuse them, you will not get PostScript errors in the output. However, it is recommended that you resolve any \TeX errors before attempting to print your document. A few PSTricks macros pass on PostScript errors without warning. Use



these with care, especially if you are using a networked printer, because PostScript errors can cause a printer to bomb. Such macros are pointed out in strong terms, using a warning like this one:

Warning: Use macros that do not check for PostScript errors with care. PostScript errors can cause a printer to bomb!

Keep in mind the following typographical conventions in this User's Guide.

- All literal input characters, i.e., those that should appear verbatim in your input file, appear in upright Helvetica and Helvetica-Bold fonts.
- Meta arguments, for which you are supposed to substitute a value (e.g., *angle*) appear in slanted *Helvetica-Oblique* and ***Helvetica-BoldOblique*** fonts.
- The main entry for a macro or parameter that states its syntax appears in a large bold font, *except for the optional arguments, which are in medium weight*. This is how you can recognize the optional arguments.
- References to PSTricks commands and parameters within paragraphs are set in **Helvetica-Bold**.

The Essentials

1 Arguments and delimiters

Here is some nitty-gritty about arguments and delimiters that is really important to know.

The PSTricks macros use the following delimiters:

Curly braces	<code>{arg}</code>
Brackets (only for optional arguments)	<code>[arg]</code>
Parentheses and commas for coordinates	<code>(x,y)</code>
= and , for parameters	<code>par1=val1, ...</code>

Spaces and commas are also used as delimiters within arguments, but in this case the argument is expanded before looking for the delimiters.

Always use a period rather than a comma to denote the decimal point, so that PSTricks doesn't mistake the comma for a delimiter.

The easiest mistake to make with the PSTricks macros is to mess up the delimiters. This may generate complaints from \TeX or PSTricks about bad arguments, or other unilluminating errors such as the following:

- ! Use of `\get@coor` doesn't match its definition.
- ! Paragraph ended before `\pst@addcoor` was complete.
- ! Forbidden control sequence found while scanning use of `\check@arrow`.
- ! File ended while scanning use of `\put`.

Delimiters are generally the first thing to check when you get errors with a PSTricks macro.

Since PSTricks macros can have many arguments, it is useful to know that you can leave a space or new line between any arguments, except between arguments enclosed in curly braces. If you need to insert a new line between arguments enclosed in curly braces, put a comment character `%` at the end of the line.

As a general rule, the first non-space character after a PSTricks macro should not be a [or (. Otherwise, PSTricks might think that the [or (is actually part of the macro. You can always get around this by inserting a pair {} of braces somewhere between the macro and the [or (.

2 Color

The grayscales

black, darkgray, gray, lightgray, and white,

and the colors

red, green, blue, cyan, magenta, and yellow

are predefined in PSTricks.

This means that these names can be used with the graphics objects that are described in later sections. This also means that the command `\gray` (or `\red`, etc.) can be used much like `\rm` or `\tt`, as in

`{\gray This stuff should be gray.}`

The commands `\gray`, `\red`, etc. can be nested like the font commands as well. There are a few important ways in which the color commands differ from the font commands:

1. The color commands can be used in and out of math mode (there are no restrictions, other than proper \TeX grouping).
2. The color commands affect whatever is in their scope (e.g., lines), not simply characters.
3. The scope of the color commands does not extend across pages.
4. The color commands are not as robust as font commands when used inside box macros. See page 89 for details. You can avoid most problems by explicitly grouping color commands (e.g., enclosing the scope in braces {}) whenever these are in the argument of another command.¹

¹However, this is not necessary with the PSTricks LR-box commands, except when `\psverbboxtrue` is in effect. See Section A.

You can define or redefine additional colors and grayscales with the following commands. In each case, *numi* is a number between 0 and 1. Spaces are used as delimiters—don't add any extraneous spaces in the arguments.

`\newgray{color}{num}`

num is the gray scale specification, to be set by PostScript's `setgray` operator. 0 is black and 1 is white. For example:

```
\newgray{darkgray}{.25}
```

`\newrgbcolor{color}{num1 num2 num3}`

num1 num2 num3 is a *red-green-blue* specification, to be set by PostScript's `setrgbcolor` operator. For example,

```
\newrgbcolor{green}{0 1 0}
```

`\newhsbcolor{color}{num1 num2 num3}`

num1 num2 num3 is an *hue-saturation-brightness* specification, to be set by PostScript's `sethsbcolor` operator. For example,

```
\newhsbcolor{mycolor}{.3 .7 .9}
```

`\newcmykcolor{color}{num1 num2 num3 num4}`

num1 num2 num3 num4 is a *cyan-magenta-yellow-black* specification, to be set by PostScript's `newcmykcolor` operator. For example,

```
\newcmykcolor{hercolor}{.5 1 0 .5}
```

For defining new colors, the *rgb* model is a sure thing. *hsb* is not recommended. *cmyk* is not supported by all Level 1 implementations of PostScript, although it is best for color printing. For more information on color models and color specifications, consult the *PostScript Language Reference Manual*, 2nd Edition (Red Book), and a color guide.

Driver notes: The command `\pstVerb` must be defined.

3 Setting graphics parameters

PSTricks uses a key-value system of graphics parameters to customize the macros that generate graphics (e.g., lines and circles), or graphics combined with text (e.g., framed boxes). You can change the default values of parameters with the command `\psset`, as in

```
\psset{fillcolor=yellow}  
\psset{linecolor=blue,framearc=.3,dash=3pt 6pt}
```

The general syntax is:

```
\psset{par1=value1,par2=value2,...}
```

As illustrated in the examples above, spaces are used as delimiters for some of the values. Additional spaces are allowed only following the comma that separates *par=value* pairs (which is thus a good place to start a new line if there are many parameter changes). E.g., the first example is acceptable, but the second is not:

```
\psset{fillcolor=yellow, linecolor=blue}  
\psset{fillcolor= yellow,linecolor =blue }
```

The parameters are described throughout this *User's Guide*, as they are needed.

Nearly every macro that makes use of graphics parameters allows you to include changes as an optional first argument, enclosed in square brackets. For example,

```
\psline[linecolor=green,linestyle=dotted](8,7)
```

draws a dotted, green line. It is roughly equivalent to

```
{\psset{linecolor=green,linestyle=dotted}\psline(8,7)}
```

For many parameters, PSTricks processes the value and stores it in a peculiar form, ready for PostScript consumption. For others, PSTricks stores the value in a form that you would expect. In the latter case, this *User's Guide* will mention the name of the command where the value is stored. This is so that you can use the value to set other parameters. E.g.,

```
\psset{linecolor=\psfillcolor,doublesep=.5\pslinewidth}
```

However, even for these parameters, PSTricks may do some processing and error-checking, and you should always set them using **\psset** or as optional parameter changes, rather than redefining the command where the value is stored.

4 Dimensions, coordinates and angles

Whenever an argument of a PSTricks macro is a dimension, the unit is optional. The default unit is set by the

unit=*dim*

Default: 1cm

parameter. For example, with the default value of 1cm, the following are equivalent:

```
\psset{linewidth=.5cm}  
\psset{linewidth=.5}
```

By never explicitly giving units, you can scale graphics by changing the value of **unit**.

You can use the default coordinate when setting non-PSTricks dimensions as well, using the commands

\pssetlength{*cmd*}{*dim*}

\psaddtolength{*cmd*}{*dim*}

where *cmd* is a dimension register (in \LaTeX parlance, a “length”), and *dim* is a length with optional unit. These are analogous to \LaTeX ’s `\setlength` and `\addtolength`.

Coordinate pairs have the form (x,y) . The origin of the coordinate system is at \TeX ’s currentpoint. The command `\SpecialCoor` lets you use polar coordinates, in the form $(r;a)$, where r is the radius (a dimension) and a is the angle (see below). You can still use Cartesian coordinates. For a complete description of `\SpecialCoor`, see Section 34.

The **unit** parameter actually sets the following three parameters:

xunit=*dim*

Default: 1cm

yunit=*dim*

Default: 1cm

runit=*dim*

Default: 1cm

These are the default units for x-coordinates, y-coordinates, and all other coordinates, respectively. By setting these independently, you can scale the x and y dimensions in Cartesian coordinate unevenly. After changing **yunit** to 1pt, the two `\psline`’s below are equivalent:

```
\psset{yunit=1pt}  
\psline(0cm,20pt)(5cm,80pt)  
\psline(0,20)(5,80)
```

The values of the **runit**, **xunit** and **yunit** parameters are stored in the dimension registers **\psunit**(also **\psrunit**), **\psxunit** and **\psyunit**.

Angles, in polar coordinates and other arguments, should be a number giving the angle in degrees, by default. You can also change the units used for angles with the command

\degrees[*num*]

num should be the number of units in a circle. For example, you might use

`\degrees[100]`

to make a pie chart when you know the shares in percentages. **\degrees** without the argument is the same as

`\degrees[360]`

The command

\radians

is short for

`\degrees[6.28319]`

\SpecialCoor lets you specify angles in other ways as well.

5 Basic graphics parameters

The width and color of lines is set by the parameters:

linewidth=*dim*
linecolor=*color*

Default: .8pt
Default: black

The **linewidth** is stored in the dimension register **\pslinewidth**, and the **linecolor** is stored in the command **\pslinecolor**.

The regions delimited by open and closed curves can be filled, as determined by the parameters:

fillstyle=style
fillcolor=color

When **fillstyle=none**, the regions are not filled. When **fillstyle=solid**, the regions are filled with **fillcolor**. Other **fillstyle**'s are described in Section 14.

The graphics objects all have a starred version (e.g., **\psframe***) which draws a solid object whose color is **linecolor**. For example,

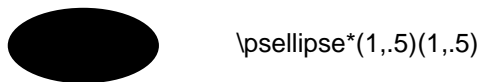

Open curves can have arrows, according to the

arrows=arrows

parameter. If **arrows=-**, you get no arrows. If **arrows=<->**, you get arrows on both ends of the curve. You can also set **arrows=->** and **arrows=<-**, if you just want an arrow on the end or beginning of the curve, respectively. With the open curves, you can also specify the arrows as an optional argument enclosed in {} brackets. This should come after the optional parameters argument. E.g.,

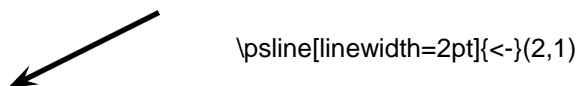

Other arrow styles are described in Section 15

If you set the

showpoints=true/false

Default: false

parameter to true, then most of the graphics objects will put dots at the appropriate coordinates or control points of the object.² Section 9 describes how to change the dot style.

²The parameter value is stored in the conditional `\ifshowpoints`.

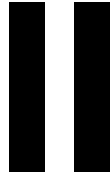

Basic graphics objects

6 Lines and polygons

The objects in this section also use the following parameters:

linearc=*dim* **Default: 0pt**

The radius of arcs drawn at the corners of lines by the `\psline` and `\pspolygon` graphics objects. *dim* should be positive.

framearc=*num* **Default: 0**

In the `\psframe` and the related box framing macros, the radius of rounded corners is set, by default, to one-half *num* times the width or height of the frame, whichever is less. *num* should be between 0 and 1.

cornersize=*relative/absolute* **Default: relative**

If **cornersize** is relative, then the **framearc** parameter determines the radius of the rounded corners for `\psframe`, as described above (and hence the radius depends on the size of the frame). If **cornersize** is absolute, then the **linearc** parameter determines the radius of the rounded corners for `\psframe` (and hence the radius is of constant size).

Now here are the lines and polygons:

`\psline*[par]{arrows}(x0,y0)(x1,y1)...(xn,yn)`

This draws a line through the list of coordinates. For example:

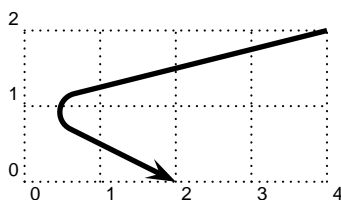

```
\psline[linewidth=2pt,linearc=.25]{->}(4,2)(0,1)(2,0)
```

`\qline(coor0)(coor1)`

- `\psset{linecolor=gray}`
`\qdisk(2,3){4pt}`

`\pswedge*[par](x0,y0){radius}{angle1}{angle2}`

This draws a wedge whose center is at (x_0, y_0) , that has radius *radius*, and that extends counterclockwise from *angle1* to *angle2*. The angles must be specified in degrees. For example:

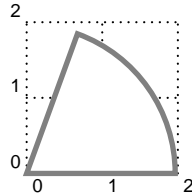

`\pswedge[linecolor=gray,linewidth=2pt,fillstyle=solid]{2}{0}{70}`

`\psellipse*[par](x0,y0)(x1,y1)`

(x_0, y_0) is the center of the ellipse, and x_1 and y_1 are the horizontal and vertical radii, respectively. For example:

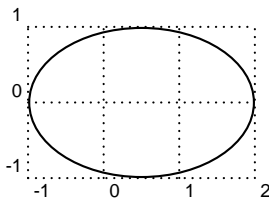

`\psellipse[fillcolor=lightgray](.5,0)(1.5,1)`

`\psarc*[par]{arrows}(x,y){radius}{angleA}{angleB}`

This draws an arc from *angleA* to *angleB*, going counter clockwise, for a circle of radius *radius* and centered at (x, y) . You must include either the *arrows* argument or the (x, y) argument. For example:

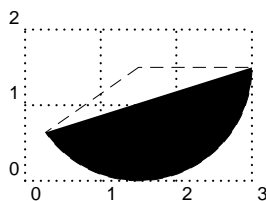

`\psarc*[showpoints=true](1.5,1.5){1.5}{215}{0}`

See how **showpoints=true** draws a dashed line from the center to the arc; this is useful when composing pictures.

`\psarc` also uses the parameters:

arcsepA=dim

Default: 0pt

angleA is adjusted so that the arc would just touch a line of width *dim* that extended from the center of the arc in the direction of *angleA*.

arcsepB=dim

Default: 0pt

This is like **arcsepA**, but *angleB* is adjusted.

arcsep=dim

Default: 0

This just sets both **arcsepA** and **arcsepB**.

These parameters make it easy to draw two intersecting lines and then use **\psarc** with arrows to indicate the angle between them. For example:

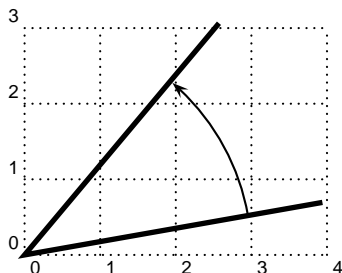

```
\SpecialCoor  
\psline[linewidth=2pt](4;50)(0,0)(4;10)  
\psarc[arcsepB=2pt]{->}{3}{10}{50}
```

\psarcn*[par]{arrows}(x,y){radius}{angleA}{angleB}

This is like **\psarc**, but the arc is drawn *clockwise*. You can achieve the same effect using **\psarc** by switching *angleA* and *angleB* and the arrows.³

8 Curves

\psbezier*[par]{arrows}(x0,y0)(x1,y1)(x2,y2)(x3,y3)

\psbezier draws a bezier curve with the four control points. The curve starts at the first coordinate, tangent to the line connecting to the second coordinate. It ends at the last coordinate, tangent to the line connecting to the third coordinate. The second and third coordinates, in addition to determining the tangency of the curve at the endpoints, also “pull” the curve towards themselves. For example:

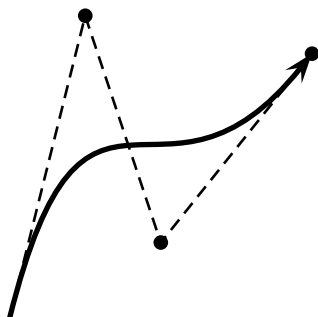

```
\psbezier[linewidth=2pt,showpoints=true]{->}(0,0)(1,4)(2,1)(4,3.5)
```

³However, with **\pscustom** graphics object, described in Part IV, **\psarcn** is not redundant.

showpoints=true puts dots in all the control points, and connects them by dashed lines, which is useful when adjusting your bezier curve.

`\parabola*[par]{arrows}(x0,y0)(x1,y1)`

Starting at $(x0,y0)$, **\parabola** draws the parabola that passes through $(x0,y0)$ and whose maximum or minimum is $(x1,y1)$. For example:

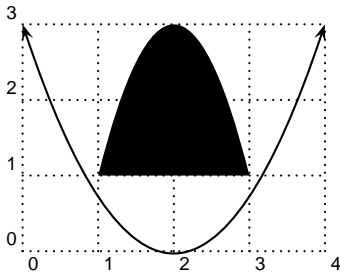

```
\parabola*(1,1)(2,3)
\psset{xunit=.01}
\parabola{<->}(400,3)(200,0)
```

The next three graphics objects interpolate an open or closed curve through the given points. The curve at each interior point is perpendicular to the line bisecting the angle ABC, where B is the interior point, and A and C are the neighboring points. Scaling the coordinates *does not* cause the curve to scale proportionately.

The curvature is controlled by the following parameter:

`curvature=num1 num2 num3` Default: 1 .1 0

You have to just play around with this parameter to get what you want. Individual values outside the range -1 to 1 are either ignored or are for entertainment only. Below is an explanation of what each number does. A, B and C refer to three consecutive points.

Lower values of *num1* make the curve tighter.

Lower values of *num2* tighten the curve where the angle ABC is greater than 45 degrees, and loosen the curve elsewhere.

num3 determines the slope at each point. If *num3*=0, then the curve is perpendicular at B to the bisection of ABC. If *num3*=-1, then the curve at B is parallel to the line AC. With this value (and only this value), scaling the coordinates causes the curve to scale proportionately. However, positive values can look better with irregularly spaced coordinates. Values less than -1 or greater than 2 are converted to -1 and 2, respectively.

Here are the three curve interpolation macros:

`\pscurve*[par]{arrows}(x1,y1)...(xn,yn)`

This interpolates an open curve through the points. For example:

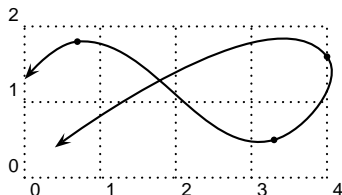

```
\pscurve[showpoints=true]{<->}(0,1.3)(0.7,1.8)
(3.3,0.5)(4,1.6)(0.4,0.4)
```

Note the use of **`showpoints=true`** to see the points. This is helpful when constructing a curve.

`\psecurve*[par]{arrows}(x1,y1)...(xn,yn)`

This is like `\pscurve`, but the curve is not extended to the first and last points. This gets around the problem of trying to determine how the curve should join the first and last points. The `e` has something to do with “endpoints”. For example:

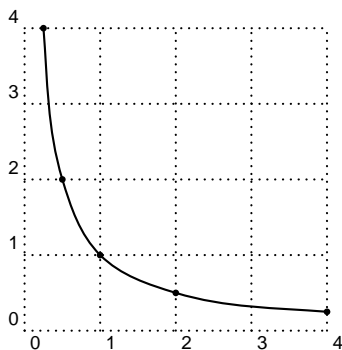

```
\psecurve[showpoints=true](.125,8)(.25,4)(.5,2)
(1,1)(2,.5)(4,.25)(8,.125)
```

`\psccurve*[par]{arrows}(x1,y1)...(xn,yn)`

This interpolates a closed curve through the points. `c` stands for “closed”. For example:

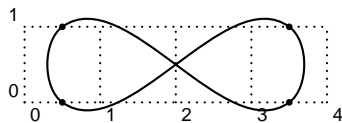

```
\psccurve[showpoints=true]
(.5,0)(3.5,1)(3.5,0)(.5,1)
```

9 Dots

The graphics object

`\psdots*[par](x1,y1)(x2,y2)...(xn,yn)`

puts a dot at each coordinate. What a “dot” is depends on the value of the

dotstyle=style **Default: ***

parameter. This also determines the dots you get when **showpoints=true**. The dot styles are also pretty intuitive:

<i>Style</i>	<i>Example</i>	<i>Style</i>	<i>Example</i>
*	• • • • •	square	◻ ◻ ◻ ◻ ◻
o	◦ ◦ ◦ ◦ ◦	square*	◻ ◻ ◻ ◻ ◻
+	+ + + + +	pentagon	◡ ◡ ◡ ◡ ◡
triangle	▲ ▲ ▲ ▲ ▲	pentagon*	◡ ◡ ◡ ◡ ◡
triangle*	▲ ▲ ▲ ▲ ▲		

As with arrows, there is a parameter for scaling the dots:

dotscale=num1 num2 **Default: 1**

The dots are scaled horizontally by *num1* and vertically by *num2*. If you only include one number, the arrows are scaled the same in both directions.

There is also a parameter for rotating the dots:

dotangle=angle **Default: 0**

Thus, e.g., by setting **dotangle=45**, the + **dotstyle** gives you an x, and the square **dotstyle** gives you a diamond. Note that the dots are first scaled and then rotated.

The unscaled size of the | dot style is controlled by the **tbar**size parameter, and the unscaled size of the remaining dot styles is controlled by the **dot**size. These are described in Section 15. The radius as determined by the value of **dot**size is the radius of solid or open circles. The other types of dots are of similar size.⁴

The dot sizes are allowed to depend on the **linewidth** because of the **showpoints** parameter. However, you can set the dot sizes to an absolute dimension by setting the second number in the **dot**size parameter to 0. E.g.,

```
\psset{dotsize=3pt 0}
```

sets the size of the dots to 3pt, independent of the value of **linewidth**.

⁴The polygons are sized to have the same area as the circles. A diamond is just a rotated square.

10 Grids

PSTricks has a powerful macro for making grids and graph paper:

\psgrid($x0,y0$)($x1,y1$)($x2,y2$)

\psgrid draws a grid with opposing corners ($x1,y1$) and ($x2,y2$). The intervals are numbered, with the numbers positioned at $x0$ and $y0$. The coordinates are always interpreted as Cartesian coordinates. For example:

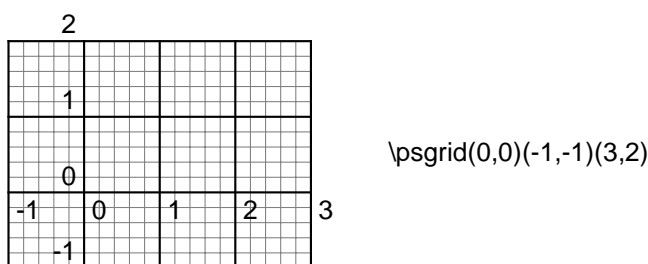

(Note that the coordinates and label positioning work the same as with **\psaxes**.)

The main grid divisions occur on multiples of **xunit** and **yunit**. Subdivisions are allowed as well. Generally, the coordinates would be given as integers, without units.

If the ($x0,y0$) coordinate is omitted, ($x1,y1$) is used. The default for ($x1,y1$) is (0,0). If you don't give any coordinates at all, then the coordinates of the current **\pspicture** environment are used or a 10x10 grid is drawn. Thus, you can include a **\psgrid** command without coordinates in a **\pspicture** environment to get a grid that will help you position objects in the picture.

The main grid divisions are numbered, with the numbers drawn next to the vertical line at $x0$ (away from $x2$) and next to the horizontal line at $y1$ (away from $y2$). ($x1,y1$) can be any corner of the grid, as long as ($x2,y2$) is the opposing corner, you can position the labels on any side you want. For example, compare

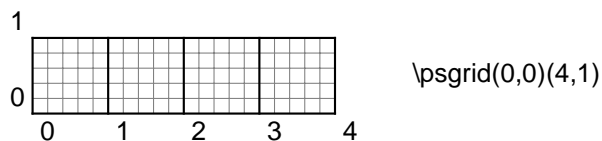

and

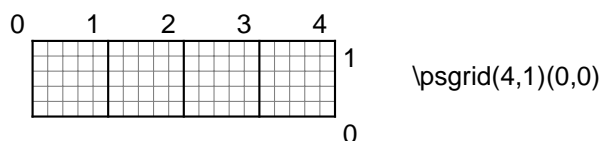

The following parameters apply only to `\psgrid`:

gridwidth=*dim* **Default: .8pt**

The width of grid lines.

gridcolor=*color* **Default: black**

The color of grid lines.

griddots=*num* **Default: 0**

If *num* is positive, the grid lines are dotted, with *num* dots per division.

gridlabels=*dim* **Default: 10pt**

The size of the numbers used to mark the grid.

gridlabelcolor=*color* **Default: black**

The color of the grid numbers.

subgriddiv=*int* **Default: 5**

The number of grid subdivisions.

subgridwidth=*dim* **Default: .4pt**

The width of subgrid lines.

subgridcolor=*color* **Default: gray**

The color of subgrid lines.

subgriddots=*num* **Default: 0**

Like **griddots**, but for subdivisions.

Here is a familiar looking grid which illustrates some of the parameters:

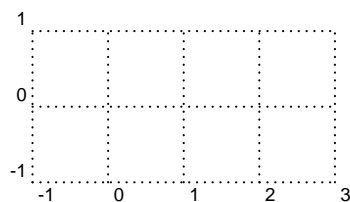

```
\psgrid[subgriddiv=1,griddots=10,gridlabels=7pt](-1,-1)(3,1)
```

Note that the values of **xunit** and **yunit** are important parameters for `\psgrid`, because they determine the spacing of the divisions. E.g., if the value of these is 1pt, and then you type

```
\psgrid(0,0)(10in,10in)
```

you will get a grid with 723 main divisions and 3615 subdivisions! (Actually, `\psgrid` allows at most 500 divisions or subdivisions, to limit the damage done by this kind of mistake.) Probably you want to set `unit` to `.5in` or `1in`, as in

```
\psgrid[unit=.5in](0,0)(20,20)
```

11 Plots



The plotting commands described in this part are defined in `pst-plot.tex/pst-plot.sty`, which you must load first.

The `\psdots`, `\psline`, `\pspolygon`, `\pscurve`, `\psecurve` and `\psccurve` graphics objects let you plot data in a variety of ways. However, first you have to generate the data and enter it as coordinate pairs (x,y) . The plotting macros in this section give you other ways to get and use the data. (Section 26 tells you how to generate axes.)

To parameter

plotstyle=style

Default: line

determines what kind of plot you get. Valid styles are `dots`, `line`, `polygon`, `curve`, `ecurve`, `ccurve`. E.g., if the **plotstyle** is `polygon`, then the macro becomes a variant of the `\pspolygon` object.

You can use arrows with the plot styles that are open curves, but there is no optional argument for specifying the arrows. You have to use the **arrows** parameter instead.



Warning: No PostScript error checking is provided for the data arguments. Read Appendix C before including PostScript code in the arguments.

*There are system-dependent limits on the amount of data T_EX and PostScript can handle. You are much less likely to exceed the PostScript limits when you use the `line`, `polygon` or `dots` plot style, with **showpoints=false**, **linearc=0pt**, and no arrows.*

Note that the lists of data generated or used by the plot commands cannot contain units. The values of `\psxunit` and `\psyunit` are used as the unit.

\fileplot*[*par*]{*file*}

\plotfile is the simplest of the plotting functions to use. You just need a file that contains a list of coordinates (without units), such as generated by Mathematica or other mathematical packages. The data can be delimited by curly braces { }, parentheses (), commas, and/or white space. Bracketing all the data with square brackets [] will significantly speed up the rate at which the data is read, but there are system-dependent limits on how much data T_EX can read like this in one chunk. (The [*must* go at the beginning of a line.) The file should not contain anything else (not even `\endinput`), except for comments marked with %.

\plotfile only recognizes the line, polygon and dots plot styles, and it ignores the **arrows**, **linearc** and **showpoints** parameters. The **\listplot** command, described below, can also plot data from file, without these restrictions and with faster T_EX processing. However, you are less likely to exceed PostScript's memory or operand stack limits with **\plotfile**.

If you find that it takes T_EX a long time to process your **\plotfile** command, you may want to use the **\PSTtoEPS** command described on page 80. This will also reduce T_EX's memory requirements.

\dataplot*[*par*]{*commands*}

\dataplot is also for plotting lists of data generated by other programs, but you first have to retrieve the data with one of the following commands:

\savedata{*command*}[*data*]

\readdata{*command*}{*file*}

data or the data in *file* should conform to the rules described above for the data in **\fileplot** (with **\savedata**, the data must be delimited by [], and with **\readdata**, bracketing the data with [] speeds things up). You can concatenate and reuse lists, as in

```
\readdata{\foo}{foo.data}
\readdata{\bar}{bar.data}
\dataplot{\foo\bar}
\dataplot[origin=(0,1)]{\bar}
```

The **\readdata** and **\dataplot** combination is faster than **\fileplot** if you reuse the data. **\fileplot** uses less of T_EX's memory than **\readdata** and **\dataplot** if you are also use **\PSTtoEPS**.

Here is a plot of $\text{Integral}(\sin(x))$. The data was generated by Mathematica, with

```
Table[{x,N[SinIntegral[x]]},{x,0,20}]
```

and then copied to this document.

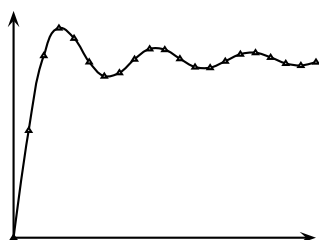

```
\psset{xunit=.2cm,yunit=1.5cm}
\savedata{\mydata}
  {{0, 0}, {1., 0.946083}, {2., 1.60541}, {3., 1.84865}, {4., 1.7582},
  {5., 1.54993}, {6., 1.42469}, {7., 1.4546}, {8., 1.57419},
  {9., 1.66504}, {10., 1.65835}, {11., 1.57831}, {12., 1.50497},
  {13., 1.49936}, {14., 1.55621}, {15., 1.61819}, {16., 1.6313},
  {17., 1.59014}, {18., 1.53661}, {19., 1.51863}, {20., 1.54824}}]
\dataplot[plotstyle=curve,showpoints=true,
  dotstyle=triangle]{\mydata}
\psline{<->}(0,2)(0,0)(20,0)
```

\listplot*[*par*]{*list*}

\listplot is yet another way of plotting lists of data. This time, *list* should be a list of data (coordinate pairs), delimited only by white space. *list* is first expanded by T_EX and then by PostScript. This means that *list* might be a PostScript program that leaves on the stack a list of data, but you can also include data that has been retrieved with **\readdata** and **\dataplot**. However, when using the line, polygon or dots plotstyles with **showpoints=false**, **linearc=0pt** and no arrows, **\dataplot** is much less likely than **\listplot** to exceed PostScript's memory or stack limits. In the preceding example, these restrictions were not satisfied, and so the example is equivalent to when **\listplot** is used:

```
...
\listplot[plotstyle=curve,showpoints=true,
  dotstyle=triangle]{\mydata}
...
```

\psplot*[*par*]{*x*_{min}}{*x*_{max}}{*function*}

\psplot can be used to plot a function $f(x)$, if you know a little PostScript. *function* should be the PostScript code for calculating $f(x)$. Note that you must use x as the dependent variable. PostScript is not designed for scientific computation, but **\psplot** is good for graphing simple functions right from within T_EX. E.g.,

```
\psplot[plotpoints=200]{0}{720}{x sin}
```

plots $\sin(x)$ from 0 to 720 degrees, by calculating $\sin(x)$ roughly every 3.6 degrees and then connecting the points with `\psline`. Here are plots of $\sin(x)$ $\cos((x=2)^2)$ and $\sin^2(x)$:

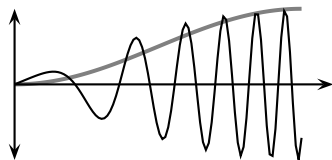

```
\psset{xunit=1.2pt}
\psplot[linecolor=gray,linewidth=1.5pt,plotstyle=curve]%
  {0}{90}{x sin dup mul}
\psplot[plotpoints=100]{0}{90}{x sin x 2 div 2 exp cos mul}
\psline{<->}(0,-1)(0,1)
\psline{->}(100,0)
```

`\parametricplot*`[*par*]{ t_{\min} }{ t_{\max} }{*function*}

This is for a parametric plot of $(x(t); y(t))$. *function* is the PostScript code for calculating the pair $x(t) y(t)$.

For example,

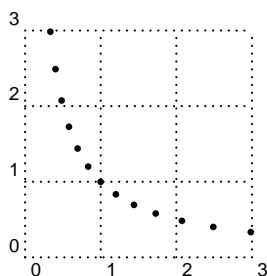

```
\parametricplot[plotstyle=dots,plotpoints=13]%
  {-6}{6}{1.2 t exp 1.2 t neg exp}
```

plots 13 points from the hyperbola $xy = 1$, starting with $(1:2^{-6}; 1:2^6)$ and ending with $(1:2^6; 1:2^{-6})$.

Here is a parametric plot of $(\sin(t); \sin(2t))$:

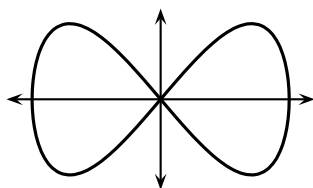

```
\psset{xunit=1.7cm}
\parametricplot[linewidth=1.2pt,plotstyle=ccurve]%
  {0}{360}{t sin t 2 mul sin}
\psline{<->}(0,-1.2)(0,1.2)
\psline{<->}(-1.2,0)(1.2,0)
```

The number of points that the `\psplot` and `\parametricplot` commands calculate is set by the

plotpoints=*int*

Default: 50

parameter. Using `curve` or its variants instead of `line` and increasing the value of **plotpoints** are two ways to get a smoother curve. Both ways increase the imaging time. Which is better depends on the complexity of the computation. (Note that all PostScript lines are ultimately rendered

as a series (perhaps short) line segments.) Mathematica generally uses `Line` to connect the points in its plots. The default minimum number of plot points for Mathematica is 25, but unlike `Plot` and `ParametricPlot`, Mathematica increases the sampling frequency on sections of the curve with greater fluctuation.

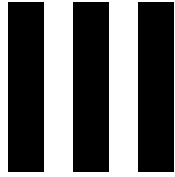

More graphics parameters

The graphics parameters described in this part are common to all or most of the graphics objects.

12 Coordinate systems

The following manipulations of the coordinate system apply only to pure graphics objects.

A simple way to move the origin of the coordinate system to (x,y) is with the

origin={*coor*}

Default: 0pt,0pt

This is the one time that coordinates *must* be enclosed in curly brackets {} rather than parentheses ().

A simple way to switch swap the axes is with the

swapaxes=true

Default: false

parameter. E.g., you might change your mind on the orientation of a plot after generating the data.

13 Line styles

The following graphics parameters (in addition to **linewidth** and **linecolor**) determine how the lines are drawn, whether they be open or closed curves.

linestyle=style

Default: solid

Valid styles are none, solid, dashed and dotted.

dash=*dim1 dim2*

Default: 5pt 3pt

The *black-white* dash pattern for the dashed line style. For example:

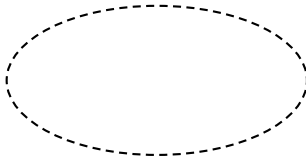

```
\psellipse[linestyle=dashed,dash=3pt 2pt](2,1)(2,1)
```

dotsep=*dim*

Default: 3pt

The distance between dots in the dotted line style. For example

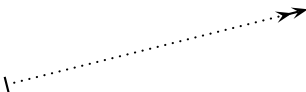

```
\psline[linestyle=dotted,dotsep=2pt]{->}(4,1)
```

border=*dim*

Default: 0pt

A positive value draws a border of width *dim* and color **bordercolor** on each side of the curve. This is useful for giving the impression that one line passes on top of another. The value is saved in the dimension register **\psborder**.

bordercolor=*color*

Default: white

See **border** above.

For example:

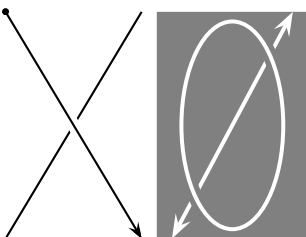

```
\psline(0,0)(1.8,3)
\psline[border=2pt]{*->}(0,3)(1.8,0)
\psframe*[linecolor=gray](2,0)(4,3)
\psline[linecolor=white,linewidth=1.5pt]{<->}(2.2,0)(3.8,3)
\psellipse[linecolor=white,linewidth=1.5pt,
bordercolor=gray,border=2pt](3,1.5)(.7,1.4)
```

doubleline=*true/false*

Default: false

When true, a double line is drawn, separated by a space that is **doublesep** wide and of color **doublecolor**. This doesn't work as expected with the dashed **linestyle**, and some arrows look funny as well.

doublesep=*dim*

Default: 1.25\pslinewidth

See **doubleline**, above.

doublecolor=*color*

Default: white

See **doubleline**, above.

Here is an example of double lines:

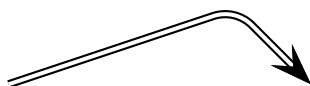

```
\psline[doubleline=true,linearc=.5,  
doublesep=1.5pt]{->}(0,0)(3,1)(4,0)
```

shadow=*true/false*

Default: false

When true, a shadow is drawn, at a distance **shadowsize** from the original curve, in the direction **shadowangle**, and of color **shadowcolor**.

shadowsize=*dim*

Default: 3pt

See **shadow**, above.

shadowangle=*angle*

Default: -45

See **shadow**, above.

shadowcolor=*color*

Default: darkgray

See **shadow**, above.

Here is an example of the **shadow** feature, which should look familiar:



```
\pspolygon[linearc=2pt,shadow=true,shadowangle=45,  
xunit=1.1](-1,-.55)(-1,.5)(-.8,.5)(-.8,.65)  
(-.2,.65)(-.2,.5)(1,.5)(1,-.55)
```

Here is another graphics parameter that is related to lines but that applies only to the closed graphics objects **\psframe**, **\pscircle**, **\psellipse** and **\pswedge**:

dimen=*outer/inner/middle*

Default: outer

It determines whether the dimensions refer to the inside, outside or middle of the boundary. The difference is noticeable when the linewidth is large:

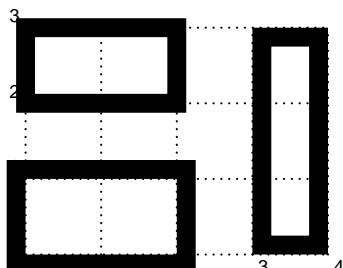

```
\psset{linewidth=.25cm}  
\psframe[dimen=inner](0,0)(2,1)  
\psframe[dimen=middle](0,2)(2,3)  
\psframe[dimen=outer](3,0)(4,3)
```

With `\pswedge`, this only affects the radius; the origin always lies in the middle the boundary. The right setting of this parameter depends on how you want to align other objects.

14 Fill styles

The next group of graphics parameters determine how closed regions are filled. Even open curves can be filled; this does not affect how the curve is painted.

`fillstyle=style` **Default: none**

Valid styles are

none, solid, vlines, vlines*, hlines, hlines*, crosshatch and crosshatch*.

vlines, hlines and crosshatch draw a pattern of lines, according to the four parameters list below that are prefixed with hatch. The * versions also fill the background, as in the solid style.

`fillcolor=color` **Default: white**

The background color in the solid, vlines*, hlines* and crosshatch* styles.

`hatchwidth=dim` **Default: .8pt**

Width of lines.

`hatchsep=dim` **Default: 4pt**

Width of space between the lines.

`hatchcolor=color` **Default: black**

Color of lines. Saved in `\pshatchcolor`.

`hatchangle=rot` **Default: 45**

Rotation of the lines, in degrees. For example, if `hatchangle` is set to 45, the vlines style draws lines that run NW-SE, and the hlines style draws lines that run SW-NE, and the crosshatch style draws both.

Here is an example of the vlines and related fill styles:

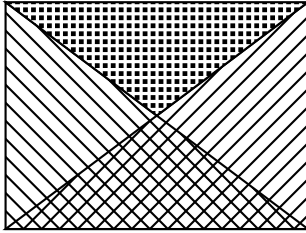

```

\pspolygon[fillstyle=vlines](0,0)(0,3)(4,0)
\pspolygon[fillstyle=hlines](0,0)(4,3)(4,0)
\pspolygon[fillstyle=crosshatch*,fillcolor=black,
  hatchcolor=white,hatchwidth=1.2pt,hatchsep=1.8pt,
  hatchangle=0](0,3)(2,1.5)(4,3)

```

Don't be surprised if the checkered part of this example (the last `\pspolygon`) looks funny on low-resolution devices. PSTricks adjusts the lines so that they all have the same width, but the space between them, which in this case is black, can have varying width.

Each of the pure graphics objects (except those beginning with `q`) has a starred version that produces a solid object of color `linecolor`. (It automatically sets `linewidth` to zero, `fillcolor` to `linecolor`, `fillstyle` to solid, and `linestyle` to none.)

15 Arrowheads and such

Lines and other open curves can be terminated with various arrowheads, t-bars or circles. The

arrows=*style*

Default: -

parameter determines what you get. It can have the following values, which are pretty intuitive:⁵

⁵This is T_EX's version of WYSIWYG.

<i>Value</i>	<i>Example</i>	<i>Name</i>
-	————	None
<->	↔	Arrowheads.
>-<	↠	Reverse arrowheads.
<<->>	↔↔	Double arrowheads.
>>-<<	↠↠	Double reverse arrowheads.
-	┌————┐	T-bars, flush to endpoints.
* *	┌————┐	T-bars, centered on endpoints.
[-]	┌————┐	Square brackets.
(-)	┌————┐	Rounded brackets.
o-o	○————○	Circles, centered on endpoints.
_	●————●	Disks, centered on endpoints.
oo-oo	○————○	Circles, flush to endpoints.
_	●————●	Disks, flush to endpoints.
c-c	————	Extended, rounded ends.
cc-cc	————	Flush round ends.
C-C	————	Extended, square ends.

You can also mix and match. E.g., ->, *-) and [-> are all valid values of the **arrows** parameter.

Well, perhaps the c, cc and C arrows are not so obvious. c and C correspond to setting PostScript's `linecap` to 1 and 2, respectively. cc is like c, but adjusted so that the line flush to the endpoint. These arrows styles are noticeable when the **linewidth** is thick:

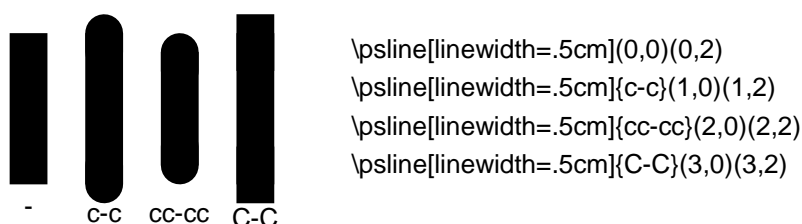

Almost all the open curves let you include the **arrows** parameters as an optional argument, enclosed in curly braces and before any other arguments (except the optional parameters argument). E.g., instead of

```
\psline[arrows=<- ,linestyle=dotted](3,4)
```

you can write

```
\psline[linestyle=dotted]{<-}(3,4)
```

The exceptions are a few streamlined macros that do not support the use of arrows (these all begin with q).

The size of these line terminators is controlled by the following parameters. In the description of the parameters, the width always refers to the dimension perpendicular to the line, and length refers to a dimension in the direction of the line.

arrowsize=*dim num* **Default: 2pt 3**

Width of arrowheads, as shown below.

arrowlength=*num* **Default: 1.4**

Length of arrowheads, as shown below.

arrowinset=*num* **Default: .4**

Size of inset for arrowheads, as shown below.

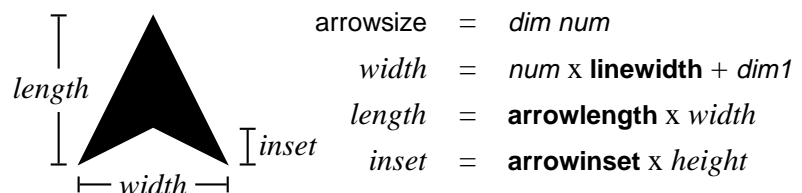

tbar size=*dim num* **Default: 2pt 5**

The width of a t-bar, square bracket or rounded bracket is *num* times **linewidth**, plus *dim*.

bracketlength=*num* **Default: .15**

The height of a square bracket is *num* times its width.

rbracketlength=*num* **Default: .15**

The height of a round bracket is *num* times its width.

dotsize=*dim num* **Default: .5pt 2.5**

The diameter of a circle or disc is *num* times **linewidth**, plus *dim*.

arrow scale=*arrow scale= num1 num2* **Default: 1**

Imagine that arrows and such point down. This scales the width of the arrows by *num1* and the length (height) by *num2*. If you only include one number, the arrows are scaled the same in both directions. Changing **arrow scale** can give you special effects not possible by changing the parameters described above. E.g., you can change the width of lines used to draw brackets.

16 Custom styles

You can define customized versions of any macro that has parameter changes as an optional first argument using the `\newpsobject` command:

```
\newpsobject{name}{object}{par1=value1,...}
```

as in

```
\newpsobject{myline}{psline}{linecolor=green,linestyle=dotted}  
\newpsobject{\mygrid}{psgrid}{subgriddiv=1,griddots=10,  
  gridlabels=7pt}
```

The first argument is the name of the new command you want to define. The second argument is the name of the graphics object. Note that both of these arguments are given without the backslash. The third argument is the special parameter values that you want to set.

With the above examples, the commands `\myline` and `\mygrid` work just like the graphics object `\psline` it is based on, and you can even reset the parameters that you set when defining `\myline`, as in:

```
\myline[linecolor=gray,dotsep=2pt](5,6)
```

Another way to define custom graphics parameter configurations is with the

```
\newpsstyle{name}{par1=value1,...}
```

command. You can then set the **style** graphics parameter to *name*, rather than setting the parameters given in the second argument of `\newpsstyle`. For example,

```
\newpsstyle{mystyle}{linecolor=green,linestyle=dotted}  
\psline[style=mystyle](5,6)
```

IV

Custom graphics

17 The basics

PSTricks contains a large palette of graphics objects, but sometimes you need something special. For example, you might want to shade the region between two curves. The

`\pscustom*[par]{commands}`

command lets you “roll you own” graphics object.

Let’s review how PostScript handles graphics. A *path* is a line, in the mathematical sense rather than the visual sense. A path can have several disconnected segments, and it can be open or closed. PostScript has various operators for making paths. The end of the path is called the *current point*, but if there is no path then there is no current point. To turn the path into something visual, PostScript can *fill* the region enclosed by the path (that is what **fillstyle** and such are about), and *stroke* the path (that is what **linestyle** and such are about).

At the beginning of **\pscustom**, there is no path. There are various commands that you can use in **\pscustom** for drawing paths. Some of these (the open curves) can also draw arrows. **\pscustom** fills and strokes the path at the end, and for special effects, you can fill and stroke the path along the way using **\psfill** and **\psstroke** (see below).

Driver notes: **\pscustom** uses **\pstverb** and **\pstunit**. There are system-dependent limits on how long the argument of **\special** can be. You may run into this limit using **\pscustom** because all the PostScript code accumulated by **\pscustom** is the argument of a single **\special** command.

18 Parameters

You need to keep the separation between drawing, stroking and filling paths in mind when setting graphics parameters. The **linewidth** and **linecolor** parameters affect the drawing of arrows, but since the path

commands do not stroke or fill the paths, these parameters, and the **linestyle**, **fillstyle** and related parameters, do not have any other effect (except that in some cases **linewidth** is used in some calculations when drawing the path). **\pscustom** and **\fill** make use of **fillstyle** and related parameters, and **\pscustom** and **\stroke** make use of **plinstyle** and related parameters.

For example, if you include

```
\psline[linewidth=2pt,linecolor=blue,fillstyle=vlines]{<-}(3,3)(4,0)
```

in **\pscustom**, then the changes to **linewidth** and **linecolor** will affect the size and color of the arrow but not of the line when it is stroked, and the change to **fillstyle** will have no effect at all.

The **shadow**, **border**, **doubleline** and **showpoints** parameters are disabled in **\pscustom**, and the **origin** and **swapaxes** parameters only affect **\pscustom** itself, but there are commands (described below) that let you achieve these special effects.

The **dashed** and **dotted** line styles need to know something about the path in order to adjust the dash or dot pattern appropriately. You can give this information by setting the

linetype=*int* **Default: 0**

parameter. If the path contains more than one disconnected segment, there is no appropriate way to adjust the dash or dot pattern, and you might as well leave the default value of **linetype**. Here are the values for simple paths:

<i>Value</i>	<i>Type of path</i>
0	Open curve without arrows.
-1	Open curve with an arrow at the beginning.
-2	Open curve with an arrow at the end.
-3	Open curve with an arrow at both ends.
1	Closed curve with no particular symmetry.
$n > 1$	Closed curve with n symmetric segments.

19 Graphics objects

You can use most of the graphics objects in **\pscustom**. These draw paths and making arrows, but do not fill and stroke the paths.

There are three types of graphics objects:

Special Special graphics objects include `\psgrid`, `\psdots`, `\qline` and `\qdisk`. You cannot use special graphics objects in `\pscustom`.

Closed You are allowed to use closed graphics objects in `\pscustom`, but their effect is unpredictable.⁶ Usually you would use the open curves plus `\closepath` (see below) to draw closed curves.

Open The open graphics objects are the most useful commands for drawing paths with `\pscustom`. By piecing together several open curves, you can draw arbitrary paths. The rest of this section pertains to the open graphics objects.

By default, the open curves draw a straight line between the current point, if it exists, and the beginning of the curve, except when the curve begins with an arrow. For example

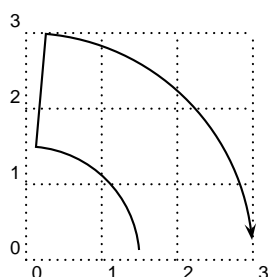

```
\pscustom{
  \psarc(0,0){1.5}{5}{85}
  \psarcn{->}(0,0){3}{85}{5}}
```

Also, the following curves make use of the current point, if it exists, as a first coordinate:

`\psline` and `\pscurve`.

The plot commands, with the line or curve **plotstyle**.

`\psbezier` if you only include three coordinates.

For example:

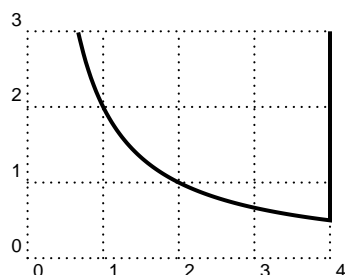

```
\pscustom[linewidth=1.5pt]{
  \psplot[plotstyle=curve]{.67}{4}{2 x div}
  \psline(4,3)}
```

⁶The closed objects never use the current point as an coordinate, but typically they will close any existing paths, and they might draw a line between the currentpoint and the closed curved.

We'll see later how to make that one more interesting. Here is another example

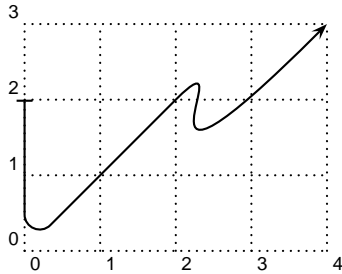

```
\pscustom{
  \psline[linearc=.2]{-}(0,2)(0,0)(2,2)
  \psbezier{->}(3,3)(1,0)(4,3)}
```

However, you can control how the open curves treat the current point with the

liftpen=0/1/2

Default: 0

parameter.

If **liftpen=0**, you get the default behavior described above. For example

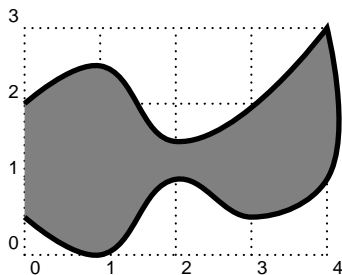

```
\pscustom[linewidth=2pt,fillstyle=solid,fillcolor=gray]{
  \pscurve(0,2)(1,2.5)(2,1.5)(4,3)
  \pscurve(4,1)(3,0.5)(2,1)(1,0)(0,.5)}
```

If **liftpen=1**, the curves do not use the current point as the first coordinate (except **\psbezier**, but you can avoid this by explicitly including the first coordinate as an argument). For example:

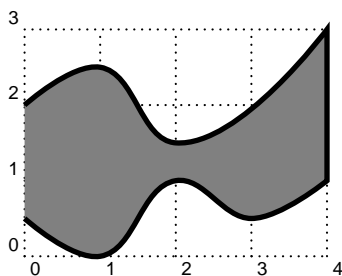

```
\pscustom[linewidth=2pt,fillstyle=solid,fillcolor=gray]{
  \pscurve(0,2)(1,2.5)(2,1.5)(4,3)
  \pscurve[liftpen=1](4,1)(3,0.5)(2,1)(1,0)(0,.5)}
```

If **liftpen=2**, the curves do not use the current point as the first coordinate, and they do not draw a line between the current point and the beginning of the curve. For example

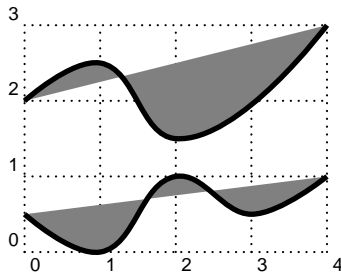

```
\pscustom[linewidth=2pt,fillstyle=solid,fillcolor=gray]{
  \pscurve(0,2)(1,2.5)(2,1.5)(4,3)
  \pscurve[liftpen=2](4,1)(3,0.5)(2,1)(1,0)(0,.5)}
```

Later we will use the second example to fill the region between the two curves, and then draw the curves.

20 Safe tricks

The commands described under this heading, which can only be used in `\pscustom`, do not run a risk of PostScript errors (assuming your document compiles without \TeX errors).

Let's start with some path, fill and stroke commands:

`\newpath`

Clear the path and the current point.

`\moveto(coor)`

This moves the current point to (x,y) .

`\closepath`

This closes the path, joining the beginning and end of each piece (there may be more than one piece if you use `\moveto`).⁷

`\stroke[par]`

This strokes the path (non-destructively). `\pscustom` automatically strokes the path, but you might want to stroke it twice, e.g., to add a border. Here is an example that makes a double line and adds a border (this example is kept so simple that it doesn't need `\pscustom` at all):

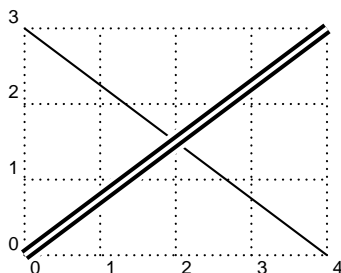

```
\psline(0,3)(4,0)
\pscustom[linecolor=white,linewidth=1.5pt]{%
  \psline(0,0)(4,3)
  \stroke[linewidth=5\pslinewidth]
  \stroke[linewidth=3\pslinewidth,linecolor=black]}
```

⁷Note that the path is automatically closed when the region is filled. Use `\closepath` if you also want to close the boundary.

`\fill[par]`

This fills the region (non-destructively). `\pscustom` automatically fills the region as well.

`\gsave`

This saves the current graphics state (i.e., the path, color, line width, coordinate system, etc.) `\grestore` restores the graphics state. `\gsave` and `\grestore` must be used in pairs, properly nested with respect to \TeX groups. You can have nested `\gsave-\grestore` pairs.

`\grestore`

See above.

Here is an example that fixes an earlier example, using `\gsave` and `\grestore`:

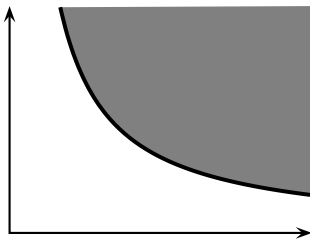

```
\psline{<->}(0,3)(0,0)(4,0)
\pscustom[linewidth=1.5pt]{
  \psplot[plotstyle=curve]{.67}{4}{2 x div}
  \gsave
    \psline(4,3)
    \fill[fillstyle=solid,fillcolor=gray]
  \grestore}
```

Observe how the line added by `\psline(4,3)` is never stroked, because it is nested in `\gsave` and `\grestore`.

Here is another example:

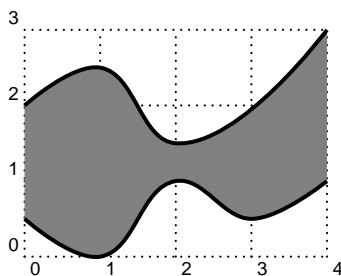

```
\pscustom[linewidth=1.5pt]{
  \pscurve(0,2)(1,2.5)(2,1.5)(4,3)
  \gsave
    \pscurve[liftpen=1](4,1)(3,0.5)(2,1)(1,0)(0,.5)
    \fill[fillstyle=solid,fillcolor=gray]
  \grestore}
\pscurve[linewidth=1.5pt](4,1)(3,0.5)(2,1)(1,0)(0,.5)
```

Note how I had to repeat the second `\pscurve` (I could have repeated it within `\pscustom`, with `liftpen=2`), because I wanted to draw a line between the two curves to enclose the region but I didn't want this line to be stroked.

The next set of commands modify the coordinate system.

\translate(*coor*)

Translate coordinate system by (x,y) . This shifts everything that comes later by (x,y) , but doesn't affect what has already been drawn.

\scale{*num1 num2*}

Scale the coordinate system in both directions by *num1*, or horizontally by *num1* and vertically by *num2*.

\rotate{*angle*}

Rotate the coordinate system by *angle*.

\swapaxes

Switch the x and y coordinates. This is equivalent to

```
\rotate{-90}  
\scale{-1 1 scale}
```

\msave

Save the current coordinate system. You can then restore it with **\mrestore**. You can have nested **\msave-\mrestore** pairs. **\msave** and **\mrestore** do not have to be properly nested with respect to \TeX groups or **\gsave** and **\grestore**. However, remember that **\gsave** and **\grestore** also affect the coordinate system. **\msave-\mrestore** lets you change the coordinate system while drawing part of a path, and then restore the old coordinate system without destroying the path. **\gsave-\grestore**, on the other hand, affect the path and all other components of the graphics state.

\mrestore

See above.

And now here are a few shadow tricks:

\openshadow[*par*]

Strokes a replica of the current path, using the various shadow parameters.

\closedshadow[*par*]

Makes a shadow of the region enclosed by the current path as if it were opaque regions.

\movepath(*coor*)

Moves the path by (x,y) . Use **\gsave-\grestore** if you don't want to lose the original path.

21 Pretty safe tricks

The next group of commands are safe, *as long as there is a current point!*

`\lineto(coor)`

This is a quick version of `\psline(coor)`.

`\rlineto(coor)`

This is like `\lineto`, but (x,y) is interpreted relative to the current point.

`\curveto(x1,y1)(x2,y2)(x3,y3)`

This is a quick version of `\psbezier(x1,y1)(x2,y2)(x3,y3)`.

`\rcurveto(x1,y1)(x2,y2)(x3,y3)`

This is like `\curveto`, but $(x1,y1)$, $(x2,y2)$ and $(x3,y3)$ are interpreted relative to the current point.

22 For hackers only



For PostScript hackers, there are a few more commands. Be sure to read Appendix C before using these. Needless to say:

Warning: Misuse of the commands in this section can cause PostScript errors.

The PostScript environment in effect with `\pscustom` has one unit equal to one $\text{T}_{\text{E}}\text{X}$ pt.

`\code{code}`

Insert the raw PostScript code.

`\dim{dim}`

Convert the PSTricks dimension to the number of pt's, and inserts it in the PostScript code.

`\coor(x1,y1)(x2,y2)...(xn,yn)`

Convert one or more PSTricks coordinates to a pair of numbers (using pt units), and insert them in the PostScript code.

\rcoor(*x1,y1*)(*x2,y2*)...(*xn,yn*)

Like **\lcoor**, but insert the coordinates in reverse order.

\file{*file*}

This is like **\lcode**, but the raw PostScript is copied verbatim (except comments delimited by %) from *file*.

\arrows{*arrows*}

This defines the PostScript operators ArrowA and ArrowB so that

```
x2 y2 x1 y1 ArrowA
x2 y2 x1 y1 ArrowB
```

each draws an arrow(head) with the tip at (*x1,y1*) and pointing from (*x2,y2*). ArrowA leaves the current point at end of the arrow-head, where a connect line should start, and leaves (*x2,y2*) on the stack. ArrowB does not change the current point, but leaves

```
x2 y2 x1' y1'
```

on the stack, where (*x1',y1'*) is the point where a connecting line should join. To give an idea of how this work, the following is roughly how PSTricks draws a bezier curve with arrows at the end:

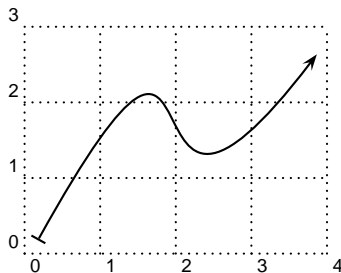

```
\pscustom{
  \arrows{[->]}
  \code{
    80 140 5 5 ArrowA
    30 -30 110 75 ArrowB
  curveto}}}
```

\setcolor{*color*}

Set the color to *color*.

V

Picture Tools

23 Pictures

The graphics objects and `\rput` and its variants do not change \TeX 's current point (i.e., they create a 0-dimensional box). If you string several of these together (and any other 0-dimensional objects), they share the same coordinate system, and so you can create a picture. For this reason, these macros are called *picture objects*.

If you create a picture this way, you will probably want to give the whole picture a certain size. You can do this by putting the picture objects in a `\pspicture` environment, as in:

```
\pspicture*[baseline](x0,y0)(x1,y1)  
picture objects \endpspicture
```

The picture objects are put in a box whose lower left-hand corner is at (x_0, y_0) (by default, $(0, 0)$) and whose upper right-hand corner is at (x_1, y_1) .

By default, the baseline is set at the bottom of the box, but the optional argument [*baseline*] sets the baseline fraction *baseline* from the bottom. Thus, *baseline* is a number, generally but not necessarily between 0 and 1. If you include this argument but leave it empty ([]), then the baseline passes through the origin.

Normally, the picture objects can extend outside the boundaries of the box. However, if you include the *, anything outside the boundaries is clipped.

Besides picture objects, you can put anything in a `\pspicture` that does not take up space. E.g., you can put in font declarations and use `\psset`, and you can put in braces for grouping. PSTricks will alert you if you include something that does take up space.⁸

\LaTeX users can type

⁸When PSTricks picture objects are included in a `\pspicture` environment, they gobble up any spaces that follow, and any preceding spaces as well, making it less likely that extraneous space gets inserted. (PSTricks objects always ignore spaces

```
\begin{pspicture} ... \end{pspicture}
```

You can use PSTricks picture objects in a \LaTeX picture environment, and you can use \LaTeX picture objects in a PSTricks **pspicture** environment. However, the **pspicture** environment makes \LaTeX 's picture environment obsolete, and has a few small advantages over the latter. Note that the arguments of the **pspicture** environment work differently from the arguments of \LaTeX 's picture environment (i.e., the right way versus the wrong way).

Driver notes: The clipping option (*) uses `\pstVerb` and `\pstverbscale`.

24 Placing and rotating whatever

PSTricks contains several commands for positioning and rotating an HR-mode argument. All of these commands end in `put`, and bear some similarity to \LaTeX 's `\put` command, but with additional capabilities. Like \LaTeX 's `\put` and unlike the box rotation macros described in Section 29, these commands do not take up any space. They can be used inside and outside **pspicture** environments.

Most of the PSTricks `put` commands are of the form:

```
\put*arg{rotation}(coor){stuff}
```

With the optional `*` argument, *stuff* is first put in a

```
\psframebox*[boxsep=false]{<stuff>}
```

thereby blotting out whatever is behind *stuff*. This is useful for positioning text on top of something else.

arg refers to other arguments that vary from one `put` command to another. The optional *rotation* is the angle by which *stuff* should be rotated; this arguments works pretty much the same for all `put` commands and is described further below. The *(coor)* argument is the coordinate for positioning *stuff*, but what this really means is different for each `put` command. The *(coor)* argument is shown to be obligatory, but you can actually omit it if you include the *rotation* argument.

that follow. If you also want them to try to neutralize preceding space when used outside the **pspicture** environment (e.g., in a \LaTeX picture environment), then use the command **\KillGlue**. The command **\DontKillGlue** turns this behavior back off.)

The *rotation* argument should be an angle, as described in Section 4, but the angle can be preceded by an *. This causes all the rotations (except the box rotations described in Section 29) within which the **\rput** command is nested to be undone before setting the angle of rotation. This is mainly useful for getting a piece of text right side up when it is nested inside rotations. For example,

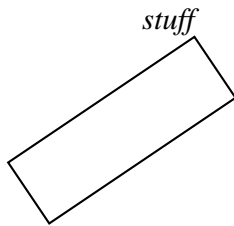

```
\rput{34}{%
  \psframe(-1,0)(2,1)
  \rput[br]{*0}(2,1){\em stuff}}
```

There are also some letter abbreviations for the command angles. These indicate which way is up:

<i>Letter</i>	<i>Short for</i>	<i>Equiv. to</i>	<i>Letter</i>	<i>Short for</i>	<i>Equiv. to</i>
U	Up	0	N	North	*0
L	Left	90	W	West	*90
D	Down	180	S	South	*180
R	Right	270	E	East	*270

This section describes just a two of the PSTricks put commands. The most basic one command is

\rput*[*refpoint*]{*rotation*}(x,y){*stuff*}

refpoint determines the reference point of *stuff*, and this reference point is translated to (x,y).

By default, the reference point is the center of the box. This can be changed by including one or two of the following in the optional *refpoint* argument:

<i>Horizontal</i>	<i>Vertical</i>
l Left	t Top
r Right	b Bottom
	B Baseline

Visually, here is where the reference point is set of the various combinations (the dashed line is the baseline):

Here is a marginal note.

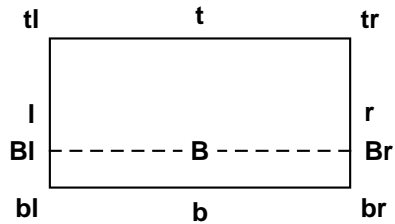

There are numerous examples of `\rput` in this documentation, but for now here is a simple one:

```
\rput[b]{90}(-1,0){Here is a marginal note.}
```

One common use of a macro such as `\rput` is to put labels on things. PSTricks has a variant of `\rput` that is especially designed for labels:

```
\uput*{labelsep}[refangle]{rotation}(x,y){stuff}
```

This places *stuff* distance *labelsep* from (x,y) , in the direction *refangle*.

The default value of *labelsep* is the dimension register

```
\pslabelsep
```

You can also change this by setting the

```
labelsep=dim
```

Default: 5pt

parameter (but remember that `\uput` does have an optional argument for setting parameters).

Here is a simple example:

```
(1,1) \qdisk(1,1){1pt}
      \uput[45](1,1){(1,1)}
```

Here is a more interesting example where `\uput` is used to make a pie chart:⁹

⁹PSTricks is distributed with a useful tool for converting data to piecharts: `piechart.sh`. This is a UNIX sh script written by Denis Girou.

```

\psset{unit=1.2cm}
\pspicture(-2.2,-2.2)(2.2,2.2)
  \pswedge[fillstyle=solid,fillcolor=gray]{2}{0}{70}
  \pswedge[fillstyle=solid,fillcolor=lightgray]{2}{70}{200}
  \pswedge[fillstyle=solid,fillcolor=darkgray]{2}{200}{360}
  \SpecialCoor
\psset{framesep=1.5pt}
\rput(1.2;35){\psframebox*{\small\$9.0M}}
\lput{2.2}[45](0,0){Oreos}
\rput(1.2;135){\psframebox*{\small\$16.7M}}
\lput{2.2}[135](0,0){Heath}
\rput(1.2;280){\psframebox*{\small\$23.1M}}
\lput{2.2}[280](0,0){M&M}
\endpspicture

```

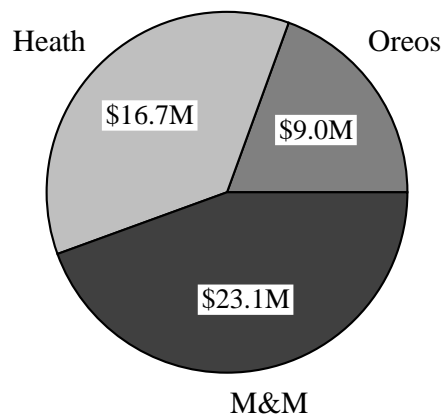

You can use the following abbreviations for *refangle*, which indicate the direction the angle points:¹⁰¹¹

¹⁰Using the abbreviations when applicable is more efficient.

¹¹There is an obsolete command **\Rput** that has the same syntax as **\lput** and that works almost the same way, except the *refangle* argument has the syntax of **\rput**'s *refpoint* argument, and it gives the point in *stuff* that should be aligned with (x, y) . E.g.,

```

\qdisk(4,0){2pt}
\Rput[tl](4,0){$(x,y)$}

```

Here is the equivalence between **\lput**'s *refangle* abbreviations and **\Rput**'s *refpoint* abbreviations:

\lput	r	u	l	d	ur	ul	dr	dl
\Rput	l	b	r	t	bl	br	tr	rl

Some people prefer **\Rput**'s convention for specifying the position of *stuff* over **\lput**'s.

<i>Letter</i>	<i>Short for</i>	<i>Equiv. to</i>	<i>Letter</i>	<i>Short for</i>	<i>Equiv. to</i>
r	right	0	ur	up-right	45
u	up	90	ul	up-left	135
l	left	180	dl	down-left	225
d	down	270	dr	down-right	315

The first example could thus have been written:

```
(1,1)      \qdisk(1,1){1pt}
.          \uput[ur](1,1){(1,1)}
```

Driver notes: The rotation macros use `\pstVerb` and `\pstrotate`.

25 Repetition

The macro

`\multirput*[refpoint]{angle}(x0,y0)(x1,y1){int}{stuff}`

is a variant of `\rput` that puts down *int* copies, starting at (x_0, y_0) and advancing by (x_1, y_1) each time. (x_0, y_0) and (x_1, y_1) are always interpreted as Cartesian coordinates. For example:

```
* * * * *
* * * * *
* * * * *
* * * * *
* * * * *
* * * * *
* * * * *
* * * * *
* * * * *
\multirput(.5,0)(.3,.1){12}{*}
```

If you want copies of pure graphics, it is more efficient to use

`\multips{angle}(x0,y0)(x1,y1){int}{graphics}`

graphics can be one or more of the pure graphics objects described in Part II, or `\pstrcustom`. Note that `\multips` has the same syntax as `\multirput`, except that there is no *refpoint* argument (since the graphics are zero dimensional anyway). Also, unlike `\multirput`, the coordinates can be of any type. An Overfull \hbox warning indicates that the *graphics* argument contains extraneous output or space. For example:



```
\defzigzag{\psline(0,0)(.5,1)(1.5,-1)(2,0)}%
\psset{unit=.25,linewidth=1.5pt}
\multips(0,0)(2,0){8}{\zigzag}
```



PSTricks is distributed with a much more general loop macro, called **multido**. You must input the file multido.tex or multido.sty. See the documentation multido.doc for details. Here is a sample of what you can do:

```
\begin{pspicture}(-3.4,-3.4)(3.4,3.4)
  \newgray{mygray}{0} % Initialize 'mygray' for benefit
  \psset{fillstyle=solid,fillcolor=mygray} % of this line.
  \SpecialCoor
  \degrees[1.1]
  \multido{\n=0.0+.1}{11}{%
    \newgray{mygray}{\n}
    \rput{\n}{\pswedge{3}{-.05}{.05}}
    \uput{3.2}{\n}(0,0){\small\n}}
\end{pspicture}
```

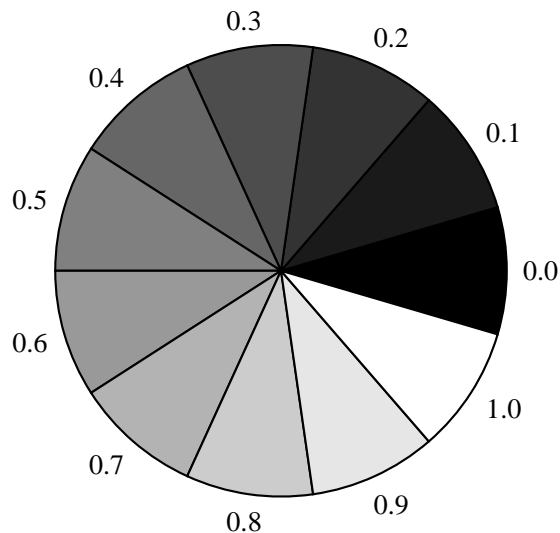

All of these loop macros can be nested.

26 Axes



The axes command described in this section is defined in pst-plot.tex / pst-plot.sty, which you must input first. pst-plot.tex, in turn, will automatically input multido.tex, which is used for putting the labels on the axes.

The macro for making axes is:

\psaxes*[par]{arrows}(x0,y0)(x1,y1)(x2,y2)

The coordinates must be Cartesian coordinates. They work the same way as with **\psgrid**. That is, if we imagine that the axes are enclosed in a rectangle, (x1,y1) and (x2,y2) are opposing corners of the rectangle. (I.e., the x-axis extends from x1 to x2 and the y-axis extends from y1 to y2.) The axes intersect at (x0,y0). For example:

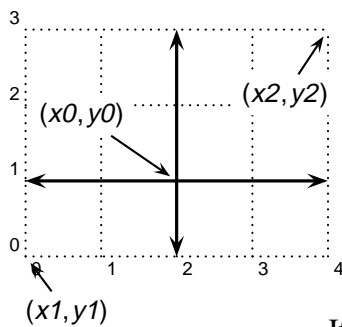

`\psaxes[linewidth=1.2pt,labels=none,
ticks=none]{<->}(2,1)(0,0)(4,3)`

If (x0,y0) is omitted, then the origin is (x1,y1). If both (x0,y0) and (x1,y1) are omitted, (0,0) is used as the default. For example, when the axes enclose a single orthont, only (x2,y2) is needed:

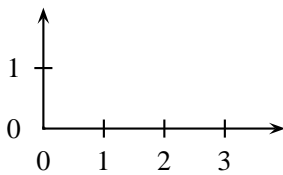

`\psaxes{->}(4,2)`

Labels (numbers) are put next to the axes, on the same side as x1 and y1. Thus, if we enclose a different orthont, the numbers end up in the right place:

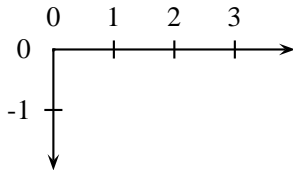

`\psaxes{->}(4,-2)`

Also, if you set the **arrows** parameter, the first arrow is used for the tips at x1 and y1, while the second arrow is used for the tips at x2 and y2. Thus, in the preceding examples, the arrowheads ended up in the right place too.¹²

¹²Including a first arrow in these examples would have had no effect because arrows are never drawn at the origin.

When the axes don't just enclose an orthont, that is, when the origin is not at a corner, there is some discretion as to where the numbers should go. The rules for positioning the numbers and arrows described above still apply, and so you can position the numbers as you please by switching $y1$ and $y2$, or $x1$ and $x2$. For example, compare

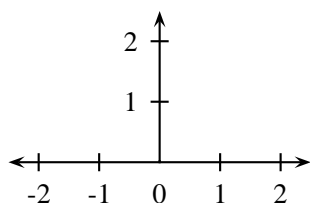

`\psaxes{<->}(0,0)(-2.5,0)(2.5,2.5)`

with what we get when $x1$ and $x2$ are switched:

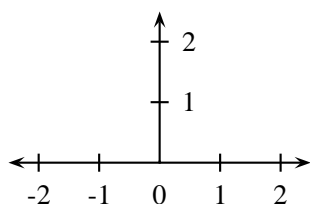

`\psaxes{<->}(0,0)(2.5,0)(-2.5,2.5)`

`\psaxes` puts the ticks and numbers on the axes at regular intervals, using the following parameters:

<i>Horitontal</i>	<i>Vertical</i>	<i>Dflt</i>	<i>Description</i>
Ox=num	Oy=num	0	Label at origin.
Dx=num	Dy=num	1	Label increment.
dx=dim	oy=dim	Opt	Dist btwn labels.

When **dx** is 0, `Dx\psxunit` is used instead, and similarly for **dy**. Hence, the default values of Opt for **dx** and **dy** are not as peculiar as they seem.

You have to be very careful when setting **Ox**, **Dx**, **Oy** and **Dy** to non-integer values. `multido.tex` increments the labels using rudimentary fixed-point arithmetic, and it will come up with the wrong answer unless **Ox** and **Dx**, or **Oy** and **Dy**, have the same number of digits to the right of the decimal. The only exception is that **Ox** or **Oy** can always be an integer, even if **Dx** or **Dy** is not. (The converse does not work, however.)¹³

¹³For example, **Ox=1.0** and **Dx=1.4** is okay, as is **Ox=1** and **Dx=1.4**, but **Ox=1.4** and **Dx=1**, or **Ox=1.4** and **Dx=1.15**, is not okay. If you get this wrong, `PSTricks` won't complain, but you won't get the right labels either.

Note that `\psaxes`'s first coordinate argument determines the physical position of the origin, but it doesn't affect the label at the origin. E.g., if the origin is at (1,1), the origin is still labeled 0 along each axis, unless you explicitly change `Ox` and `Oy`. For example:

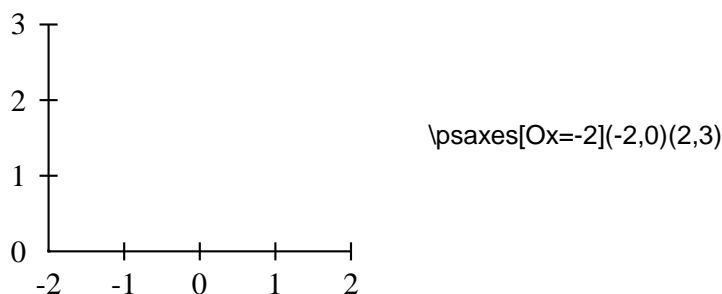

The ticks and labels use a few other parameters as well:

labels=*all/x/y/none* **Default: all**

To specify whether labels appear on both axes, the x-axis, the y-axis, or neither.

showorigin=*true/false* **Default: true**

If true, then labels are placed at the origin, as long as the label doesn't end up on one of the axes. If false, the labels are never placed at the origin.

ticks=*all/x/y/none* **Default: all**

To specify whether ticks appear on both axes, the x-axis, the y-axis, or neither.

tickstyle=*full/top/bottom* **Default: full**

For example, if **tickstyle=top**, then the ticks are only on the side of the axes away from the labels. If **tickstyle=bottom**, the ticks are on the same side as the labels. **full** gives ticks extending on both sides.

ticksize=*dim* **Default: 3pt**

Ticks extend *dim* above and/or below the axis.

The distance between ticks and labels is `\pslabelsep`, which you can change with the `labelsep` parameter.

The labels are set in the current font (one of the examples above were preceded by `\small` so that the labels would be smaller). You can do fancy things with the labels by redefining the commands:

\psxlabel

\psylabel

E.g., if you want change the font of the horizontal labels, but not the vertical labels, try something like

```
\def\psxlabel#1{\small #1}
```

You can choose to have a frame instead of axes, or no axes at all (but you still get the ticks and labels), with the parameter:

axesstyle=axes/frame/none

Default: axes

The usual **linestyle**, **fillstyle** and related parameters apply.

For example:

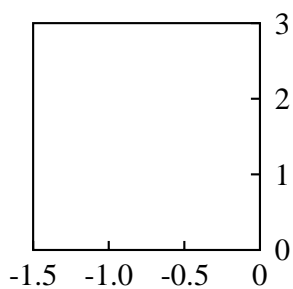

```
\psaxes[Dx=.5,dx=1,tickstyle=top,axesstyle=frame](-3,3)
```

The **\psaxes** macro is pretty flexible, but PSTricks contains some other tools for making axes from scratch. E.g., you can use **\psline** and **\psframe** to draw axes and frames, respectively, **\multido** to generate labels (see the documentation for `multido.tex`), and **\multips** to make ticks.

VI

Text Tricks

27 Framed boxes

The macros for framing boxes take their argument, put it in an `\hbox`, and put a PostScript frame around it. (They are analogous to L^AT_EX's `\fbox`). Thus, they are composite objects rather than pure graphics objects. In addition to the graphics parameters for `\psframe`, these macros use the following parameters:

framesep=*dim* **Default: 3pt**

Distance between each side of a frame and the enclosed box.

boxsep=*true/false* **Default: true**

When true, the box that is produced is the size of the frame or whatever that is drawn around the object. When false, the box that is produced is the size of whatever is inside, and so the frame is “transparent” to T_EX. This parameter only applies to `\psframebox`, `\pscirclebox`, and `\psovalbox`.

Here are the three box-framing macros:

`\psframebox*[par]{stuff}`

A simple frame (perhaps with rounded corners) is drawn using `\psframe`. The `*` option is of particular interest. It generates a solid frame whose color is **fillcolor** (rather than **linecolor**, as with the closed graphics objects). Recall that the default value of **fillcolor** is white, and so this has the effect of blotting out whatever is behind the box. For example,

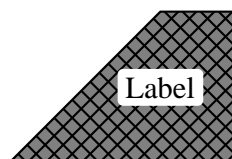

```
\pspolygon[fillcolor=gray,fillstyle=crosshatch*](0,0)(3,0)
(3,2)(2,2)
\rput(2,1){\psframebox*[framearc=.3]{Label}}
```



`\psdblframebox*[par]{stuff}`

This draws a double frame. It is just a variant of `\psframebox`, defined by

```
\newpsobject{psdblframebox}{psframebox}{doublesep=\pslinewidth}
```

For example,

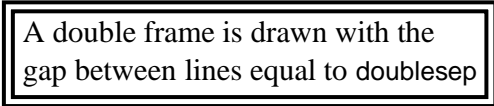
```
\psdblframebox[linewidth=1.5pt]{%  
  \parbox[c]{6cm}{\raggedright A double frame is drawn  
  with the gap between lines equal to {tt doublesep}}}
```



`\psshadowbox*[par]{stuff}`

This draws a single frame, with a shadow.

Great Idea!!

```
\psshadowbox{\bf Great Idea!!}
```

You can get the shadow with `\psframebox` just by setting the **shadowsize** parameter, but with `\psframebox` the dimensions of the box won't reflect the shadow (which may be what you want!).

`\pscirclebox*[par]{stuff}`

This draws a circle. With **boxsep=true**, the size of the box is close to but may be larger than the size of the circle. For example:

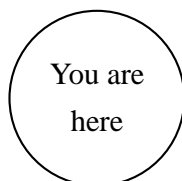

```
\pscirclebox{\begin{tabular}{c} You are \\ here \end{tabular}}
```

`\cput*[par]{angle}(x,y){stuff}`

This combines the functions of `\pscirclebox` and `\rput`. It is like

```
\rput{<angle>}(x0,y0){\string\pscirclebox*[<par>]{<stuff>}}
```

but it is more efficient. Unlike the `\rput` command, there is no argument for changing the reference point; it is always the center of the box. Instead, there is an optional argument for changing graphics parameters. For example

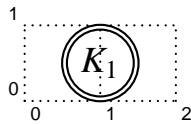

`\cput[doubleline=true](1,.5){\large K_1}`

`\psovalbox*[par]{stuff}`

This draws an ellipse. If you want an oval with square sides and rounded corners, then use **`\psframebox`** with a positive value for **`rectarc`** or **`linearc`** (depending on whether **`cornersize`** is relative or absolute). Here is an example that uses **`boxsep=false`**:

At the introductory price of \$13.99, it pays to act now!

At the introductory price of `\psovalbox[boxsep=false,linecolor=darkgray]{\$13.99}`, it pays to act now!

You can define variants of these box framing macros using the **`\newpsubject`** command.

If you want to control the final size of the frame, independently of the material inside, nest *stuff* in something like L^AT_EX's `\makebox` command.

28 Clipping

The command

`\clipbox[dim]{stuff}`

puts *stuff* in an `\hbox` and then clips around the boundary of the box, at a distance *dim* from the box (the default is 0pt).

The **`\pspicture`** environment also lets you clip the picture to the boundary.

The command

`\psclip{graphics} ... \endpsclip`

sets the clipping path to the path drawn by the graphics object(s), until the **`\endpsclip`** command is reached. **`\psclip`** and **`\endpsclip`** must be properly nested with respect to T_EX grouping. Only pure graphics (those described in Part II and **`\pscustom`**) are permitted. An Overfull `\hbox` warning indicates that the *graphics* argument contains extraneous output or space. Note that the graphics objects otherwise act as usual, and the **`\psclip`** does not otherwise affect the surrounded text. Here is an example:

“One of the best new plays I have seen all year: cool, poetic, ironic ...” proclaimed *The Guardian* upon the London premiere of this extraordinary play about a Czech director and his actress wife, confronting exile in America.

```
\parbox{4.5cm}{%
  \psclip{\psccurve[linestyle=none](-3,-2)
    (0.3,-1.5)(2.3,-2)(4.3,-1.5)(6.3,-2)(8,-1.5)(8,2)(-3,2)}
  “One of the best new plays I have seen all year: cool, poetic,
  ironic \dots” proclaimed {\em The Guardian} upon the London
  premiere of this extraordinary play about a Czech director and
  his actress wife, confronting exile in America.\vspace{-1cm}
  \endpsclip}
```

If you don't want the outline to be painted, you need to include **linestyle=none** in the parameter changes. You can actually include more than one graphics object in the argument, in which case the clipping path is set to the intersection of the paths.

\psclip can be a useful tool in picture environments. For example, here it is used to shade the region between two curves:

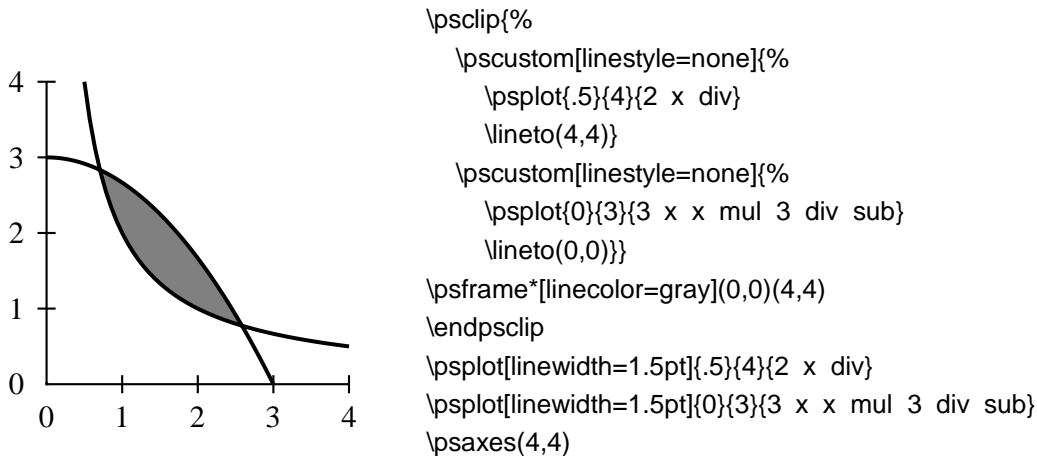

Driver notes: The clipping macros use **\pstverbscale** and **\pstVerb**. Don't be surprised if PSTricks's clipping does not work or causes problem—it is never robust. **\endpsclip** uses **initclip**. This can interfere with other clipping operations, and especially if the T_EX document is converted to an Encapsulated PostScript file. The command **\AltClipMode** causes **\psclip** and **\endpsclip** to use **gsave** and **grestore** instead. This bothers some drivers, such as NeXTTeX's TeXView, especially if **\psclip** and **\endpsclip** do not end up on the same page.

29 Rotation and scaling boxes

There are versions of the standard box rotation macros:

\rotateleft{stuff}

`\rotateright{stuff}`

`\rotatedown{stuff}`

stuff is put in an `\hbox` and then rotated or scaled, leaving the appropriate amount of spaces. Here are a few uninteresting examples:

Left
Down
Right

`\Large\bf \rotateleft{Left} \rotatedown{Down} \rotateright{Right}`

There are also two box scaling macros:

`\scalebox{num1 num2}{stuff}`

If you give two numbers in the first argument, *num1* is used to scale horizontally and *num2* is used to scale vertically. If you give just one number, the box is scaled by the same in both directions. You can't scale by zero, but negative numbers are OK, and have the effect of flipping the box around the axis. You never know when you need to do something like `\scalebox{-1 1}{this}`.

`\scaleboxto(x,y){stuff}`

This time, the first argument is a (Cartesian) coordinate, and the box is scaled to have width *x* and height (plus depth) *y*. If one of the dimensions is 0, the box is scaled by the same amount in both directions. For example:

Big and long

`\scaleboxto(4,2){Big and long}`

PSTricks defines LR-box environments for all these box rotation and scaling commands:

```
\pslongbox{Rotateleft}{\rotateleft}
\pslongbox{Rotateright}{\rotateright}
\pslongbox{Rotatedown}{\rotatedown}
\pslongbox{Scalebox}{\scalebox}
\pslongbox{Scaleboxto}{\scaleboxto}
```

Here is an example where we **\Rotatedown** for the answers to exercises:

Question: How do
Democrats organize a
firing squad?
... a circle, ...
Answer: First they get in

```
Question: How do Democrats organize a firing squad?  
\begin{Rotatedown}  
  \parbox{\hsize}{Answer: First they get in a circle, \dots\hss}%  
\end{Rotatedown}
```

See the documentation of fancybox.sty for tips on rotating a \LaTeX table or figure environment, and other boxes.

VIII

Nodes and Node Connections



All the commands described in this part are contained in the file `pst-node.tex/pst-node.sty`.

The node and node connection macros let you connect information and place labels, without knowing the exact position of what you are connecting or of where the lines should connect. These macros are useful for making graphs and trees, mathematical diagrams, linguistic syntax diagrams, and connecting ideas of any kind. They are the trickiest tricks in PSTricks!

Although you might use these macros in pictures, positioning and rotating them with `\rput`, you can actually use them anywhere. For example, I might do something like this in a guide about page styles:

With the `myfooters` page style, the name of the current section appears at the bottom of each page.

```
\makeatletter
\gdefps@temp{\def\@oddhead{}\def\@evenhead{}
\def\@oddfoot{\small\sf
\ovalnode[boxsep=false]{A}{\rightmark}
\ncurve[ncurv=.5,angleB=240,angleA=180,nodesep=6pt]{<-}{A}{B}
\hfil\thepage}
\let\@evenfoot\@oddfoot}
\makeatother
\thispagestyle{temp}
```

With the `{\tt myfooters}` page style, the name of the current section appears at the bottom of each `\node{B}{page}`.

You can use nodes in math mode and in alignment environments as well. Here is an example of a commutative diagram:

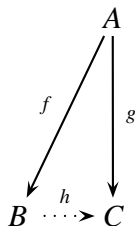

```

$
\begin{array}{c@{\hspace 1cm}c}
& \rnode{a}{A}\l[2cm] \\
& \rnode{b}{B} & \rnode{c}{C} \\
\end{array}
\psset{nodesep=3pt}
\everypsbox{\scriptstyle}
\incline{->}{a}{b}\Bput{f}
\incline{->}{a}{c}\Aput{g}
\incline[linestyle=dotted]{->}{b}{c}\Aput{h}
$

```

There are three components to the node macros:

Node definitions The node definitions let you assign a name and shape to an object. See Section 30.

Node connections The node connections connect two nodes, identified by their names. See Section 31.

Node labels The node label commands let you affix labels to the node connections. See Section 32.

30 Nodes



The *name* of a node must contain only letters and numbers, and must begin with a letter.

Warning: Bad node names can cause PostScript errors.

`\rnode[refpoint]{name}{stuff}`

This assigns the *name* to the node, which will have a rectangular shape for the purpose of making connections, with the “center” at the reference point (i.e., node connections will point to the reference point. **`\rnode`** was used in the two examples above.

`\Rnode(x,y){name}{stuff}`

This is like **`\rnode`**, but the reference point is calculated differently. It is set to the middle of the box’s baseline, plus (x,y) . If you omit the (x,y) argument, command

`\RnodeRef`

is substituted. The default definition of `\RnodeRef` is `0,.7ex`. E.g, the following are equivalent:

```
\Rnode(0,.6ex){stuff}
{\def\RnodeRef{0,.6ex}\Rnode{stuff}}
```

`\Rnode` is useful when aligning nodes by their baselines, such as in commutative diagrams. With `\rnode` horizontal node connections might not be quite horizontal, because of differences in the size of letters.

`\pnode(x,y){name}`

This creates a zero dimensional node at the point (x,y) (default $(0,0)$).

`\cnode*[par](x,y){radius}{name}`

This draws a circle and assigns the *name* to it.

`\circnode*[par]{name}{stuff}`

This is a variant of `\pscirclebox` that gives the node the shape of the circle.

`\cnodeput*[par]{angle}(x,y){name}{stuff}`

This is a variant of `\cput` that gives the node the shape of the circle.

`\ovalnode*[par]{name}{stuff}`

This is a variant of `\psovalbox` that gives the node the shape of the ellipse.

The reason that there is no `\framenode` command is that using `\psframebox` (or `\psshadowbox` or `\psdblframebox`) in the argument of `\rnode` gives the desired result.

31 Node connections

All the node connection commands begin with `nc`, and they all have the same syntax:

```
\<nodeconnection>[<par>]{<arrows>}{<nodeA>}{<nodeB>}
```

A line of some sort is drawn from *nodeA* to *nodeB*. Some of the node connection commands are a little confusing, but with a little experimentation you will figure them out, and you will be amazed at the things you can do.

The node and point connections can be used with `\pscustom`. The beginning of the node connection is attached to the current point by a straight line, as with `\psarc`.¹⁴

When we refer to the A and B nodes below, we are referring only to the order in which the names are given as arguments to the node connection macros.

When a node name cannot be found on the same page as the node connection command, you get either no node connection or a nonsense node connection. However, \TeX will not report any errors.

The node connections use the following parameters:

nodesep=*dim* Default: 0

The border around the nodes added for the purpose of determining where to connect the lines.

offset=*dim* Default: 0

After the node connection point is calculated, it is shift up for *nodeA* and down for *nodeB* by *dim*, where “up” and “down” assume that the connecting line points to the right from the node.

arm=*dim* Default: 10pt

Some node connections start with a segment of length *dim* before turning somewhere.

angle=*angle* Default: 0

Some node connections let you specify the angle that the node connection should connect to the node.

arcangle=*angle* Default: 8

This applies only to `\ncarc`, and is described below.

ncurv=*num* Default: .67

This applies only to `\nccurve` and `\pccurve`, and is described below.

¹⁴See page 71 if you want to use the nodes as coordinates in other PSTricks macros.

loopsize=*dim*

Default: 1cm

This applies only the `\ncloop` and `\pcloop`, and is described below.

You can set these parameters separately for the two nodes. Just add an A or B to the parameter name. E.g.

```
\psset{nodesepA=3pt, offsetA=5pt, offsetB=3pt, arm=1cm}
```

sets **nodesep** for the A node, but leaves the value for the B node unchanged, sets **offset** for the A and B nodes to different values, and sets **arm** for the A and B nodes to the same value.

Don't forget that by using the **border** parameter, you can create the impression that one node connection passes over another.

Here is a description of the individual node connection commands:

\ncline*[*par*]{*arrows*}{*nodeA*}{*nodeB*}

This draws a straight line between the nodes. Only the **offset** and **nodesep** parameters are used.

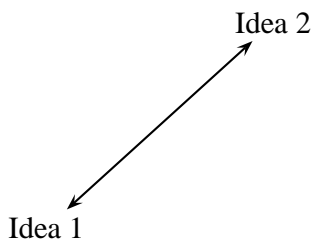

```
\rput[bl](0,0){\rnode{A}{Idea 1}}  
\rput[tr](4,3){\rnode{B}{Idea 2}}  
\ncline[nodesep=3pt]{<->}{A}{B}
```

\ncLine*[*par*]{*arrows*}{*nodeA*}{*nodeB*}

This is like `\ncline`, but the labels (with `\rput`, etc) are positioned as if the line began and ended at the center of the nodes. This is useful if you have multiple parallel lines and you want the labels to line up, even though the nodes are of varying size, e.g., in commutative diagrams.

\nccurve*[*par*]{*arrows*}{*nodeA*}{*nodeB*}

This draws a bezier curve between the nodes. It uses the **nodesep**, **offset**, **angle** and **ncurv** parameters.

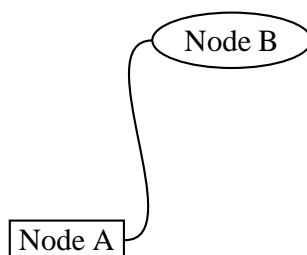

```
\rput[bl](0,0){\rnode{A}{\psframebox{Node A}}}  
\rput[tr](4,3){\ovalnode{B}{Node B}}  
\nccurve[angleB=180]{A}{B}
```

`\ncarc*[par]{arrows}{nodeA}{nodeB}`

This is actually a variant of `\ncurve`. I.e., it also connects the nodes with a bezier curve, using the `nodesep`, `offset`, and `ncurv` parameters. However, the curve connects to node A at an angle `arcangleA` from the line between A and B, and connects to node B at an angle `-arcangleB` from the line between B and A. For small, equal values of `angleA` and `angleB` (e.g., the default value of 8) and with the default value of `ncurv`, the curve approximates an arc of a circle. `\ncarc` is a nice way to connect two nodes with two lines.

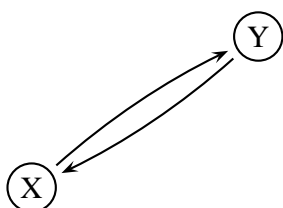

```
\nodeput(0,0){A}{X}
\nodeput(3,2){B}{Y}
\psset{nodesep=3pt}
\nccarc{->}{A}{B}
\nccarc{->}{B}{A}
```

`\ncbar*[par]{arrows}{nodeA}{nodeB}`

First, lines are drawn attaching to both nodes at an angle `angleA` and of lengths `armA` and `armB`. Then one of the arms is extended so that when the two are connected, the finished line contains 3 segments meeting at right angles. Generally, the whole line has three straight segments. The value of `linearc` is used for rounding the corners.

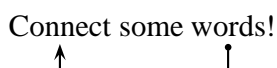

```
\rnode{A}{Connect} some \rnode{B}{words}!
\nccbar[nodesep=3pt,angle=-90]{<-*}{A}{B}
```

`\ncdiag*[par]{arrows}{nodeA}{nodeB}`

First, the arms are drawn using `angle` and `arm`. Then they are connected with a straight line. Generally, the whole line has three straight segments. The value of `linearc` is used for rounding the corners.

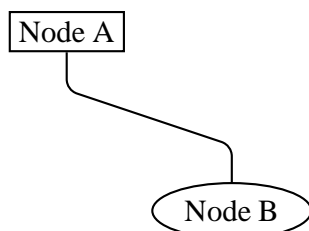

```
\rput[tl](0,3){\rnode{A}{\psframebox{Node A}}}
\rput[br](4,0){\ovalnode{B}{Node B}}
\nccdiag[angleA=-90,angleB=90,arm=.5,linearc=.2]{A}{B}
```

`\ncdiagg*[par]{arrows}{nodeA}{nodeB}`

This is similar to `\ncdiag`, but only the arm for node A is drawn. The end of this arm is then connected directly to node B. The connection typically has two segments. The value of `linearc` is used for rounding the corners.

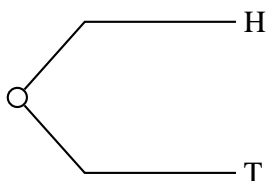

```
\cnode(0,0){4pt}{a}
\lput[l](3,1){\node{b}{H}}
\lput[l](3,-1){\node{c}{T}}
\ncdiagg[angleA=180,armA=2cm,nodesepA=3pt]{b}{a}
\ncdiagg[angleA=180,armA=2cm,nodesepA=3pt]{c}{a}
```

`\ncangle*[par]{arrows}{nodeA}{nodeB}`

The node connection points are determined by `angleA` and `angleB` (and `nodesep` and `offset`). Then an arm is drawn for node B using `armB`. This arm is connected to node A by a right angle, that also meets node A at angle `angleA`. Generally, the whole line has three straight segments, but it can have fewer. The value of `linearc` is used for rounding the corners. Simple, right? Here is an example:

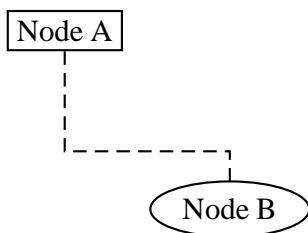

```
\lput[tl](0,3){\node{A}{\psframebox{Node A}}}
\lput[br](4,0){\ovalnode{B}{Node B}}
\ncangle[angleA=-90,angleB=90,arm=.4cm,
linestyle=dashed]{A}{B}
```

`\ncangles*[par]{arrows}{nodeA}{nodeB}`

This is similar to `\ncangle`, but both `armA` and `armB` are used. The arms are connected by a right angle that meets arm A at a right angle as well. Generally there are four segments (hence one more angle than `\ncangle`, and hence the s in `\ncangles`). The value of `linearc` is used for rounding the corners. Compare this example with the previous one:

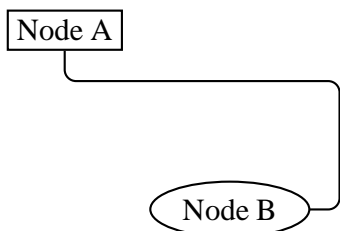

```
\lput[tl](0,3){\node{A}{\psframebox{Node A}}}
\lput[br](4,0){\ovalnode{B}{Node B}}
\ncangles[angleA=-90,arm=.4cm,linearc=.15]{A}{B}
```

`\ncloop*`[*par*]{*arrows*}{*nodeA*}{*nodeB*}

The first segment is **armA**, then it makes a 90 degree turn to the left, drawing a segment of length **loopsize**. The next segment is again at a right angle; it connects to **armB**. For example:

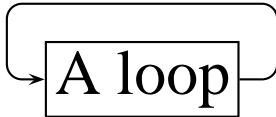

```
\rnode{a}{\psframebox{\Huge A loop}}  
\ncloop[angleB=180,loopsize=1,arm=.5,linearc=.2]{->}{a}{a}
```

`\nccircle*`[*par*]{*arrows*}{*node*}{*radius*}

This draws a circle from a node to itself. It is the only node connection command of this sort. The circle starts at angle **angleA** and goes around the node counterclockwise, at a distance **nodesepA** from the node.

The node connection commands make interesting drawing tools as well, as an alternative to `\psline` for connecting two points. There are variants of the node connection commands for this purpose. Each begins with `pc` (for “point connection”) rather than `nc`. E.g.,

```
\pcarc{<->}(3,4)(6,9)
```

gives the same result as

```
\pnode(3,4){A}\pnode(6,9){B}\pcarc{<->}{A}{B}
```

Only `\ncLine` and `\nccircle` do not have `pc` variants:

`\pcline*`[*par*]{*arrows*}(*x1*,*y1*)(*x2*,*y2*)

Like `\ncline`.

`\pccurve*`[*par*]{*arrows*}(*x1*,*y1*)(*x2*,*y2*)

Like `\nccurve`.

`\pcarc*`[*par*]{*arrows*}(*x1*,*y1*)(*x2*,*y2*)

Like `\ncarc`.

`\pcbar*`[*par*]{*arrows*}(*x1*,*y1*)(*x2*,*y2*)

Like `\ncbar`.

`\pcdiag*`[*par*]{*arrows*}(*x1*,*y1*)(*x2*,*y2*)

Like `\ncdiag`.

`\pcangle*[par]{arrows}(x1,y1)(x2,y2)`

Like `\ncangle`.

`\pcloop*[par]{arrows}(x1,y1)(x2,y2)`

Like `\ncloop`.

32 Attaching labels to node connections

Now we come to the commands for attaching labels to the node connections. The node label command must come right after the node connection to which the label is to be attached. You can attach more than one label to a node connection, and a label can include more nodes.

The node label commands must end up on the same \TeX page as the node connection to which the label corresponds.

The coordinate argument in other PSTricks put commands is a single number in the node label commands: (*pos*). This number selects a point on the node connection, roughly according to the following scheme: Each node connection has potentially one or more segments, including the arms and connecting lines. A number *pos* between 0 and 1 picks a point on the first segment from node A to B, (fraction *pos* from the beginning to the end of the segment), a number between 1 and 2 picks a number on the second segment, and so on. Each node connection has its own default value of the positioning coordinate, which is used by some short versions of the label commands.

Here are the details for each node connection:

<i>Connection</i>	<i>Segments</i>	<i>Range</i>	<i>Default</i>
<code>\ncline</code>	1	$0 \leq pos \leq 1$	0.5
<code>\nccurve</code>	1	$0 \leq pos \leq 1$	0.5
<code>\ncarc</code>	1	$0 \leq pos \leq 1$	0.5
<code>\ncbar</code>	3	$0 \leq pos \leq 3$	1.5
<code>\ncdiag</code>	3	$0 \leq pos \leq 3$	1.5
<code>\ncdiagg</code>	2	$0 \leq pos \leq 2$	0.5
<code>\ncangle</code>	3	$0 \leq pos \leq 3$	1.5
<code>\ncloop</code>	5	$0 \leq pos \leq 4$	2.5
<code>\nccircle</code>	1	$0 \leq pos \leq 1$	0.5

There is another difference between the node label commands and other put commands. In addition to the various ways of specifying the angle

of rotation for `\rput`, with the node label commands the angle can be of the form `{:angle}`. In this case, the angle is calculated after rotating the coordinate system so that the node connection at the position of the label points to the right (from nodes A to B). E.g., if the angle is `{:U}`, then the label runs parallel to the node connection.

Here are the node label commands:

`\lput*[refpoint]{rotation}(pos){stuff}`

The `l` stands for “label”. Here is an example illustrating the use of the optional star and `:angle` with `\lput`, as well as the use of the `offset` parameter with `\pcline`:

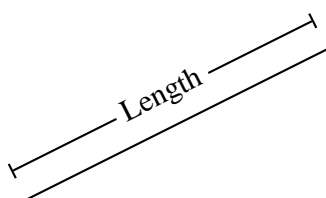

```
\pspolygon(0,0)(4,2)(4,0)
\pcline[offset=12pt]{|-}(0,0)(4,2)
\lput*{:U}{Length}
```

(Remember that with the `put` commands, you can omit the coordinate if you include the angle of rotation. You are likely to use this feature with the node label commands.)

With `\lput` and `\rput`, you have a lot of control over the position of the label. E.g.,

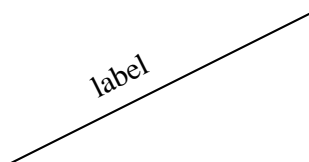

```
\pcline(0,0)(4,2)
\lput{:U}{\rput[r]{N}(0,.4){label}}
```

puts the label upright on the page, with right side located .4 centimeters “above” the position .5 of the node connection (above if the node connection points to the right). However, the `\lput` and `\bput` commands described below handle the most common cases without `\rput`.¹⁵

¹⁵There is also an obsolete command `\Lput` for putting labels next to node connections. The syntax is

```
\Lput{<labelsep>}[<refpoint>][<rotation>](<pos>){<stuff>}
```

It is a combination of `\Rput` and `\lput`, equivalent to

```
\lput(<pos>)(\Rput{<labelsep>}[<refpoint>][<rotation>](0,0){<stuff>}}
```

`\lput` is a short version of `\Lput` with no `{rotation}` or `(pos)` argument. `\Lput` and `\Mput` remain part of PSTricks only for backwards compatibility.

`\aput*[labelsep]{angle}(pos){stuff}`

stuff is positioned distance `\pslabelsep` above the node connection, given the convention that node connections point to the right. `\aput` is a node-connection variant of `\uput`. For example:

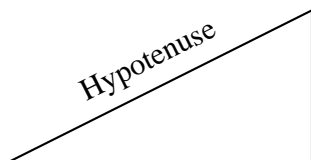

```
\pspolygon(0,0)(4,2)(4,0)
\pcline[linestyle=none](0,0)(4,2)
\aput{:U}{Hypotenuse}
```

`\bput*[labelsep]{angle}(pos){stuff}`

This is like `\aput`, but *stuff* is positioned below the node connection.

It is fairly common to want to use the default position and rotation with these node connections, but you have to include at least one of these arguments. Therefore, PSTricks contains some variants:

`\mput*[refpoint]{stuff}`

`\Aput*[labelsep]{stuff}`

`\Bput*[labelsep]{stuff}`

of `\put`, `\aput` and `\bput`, respectively, that have no angle or positioning argument. For example:

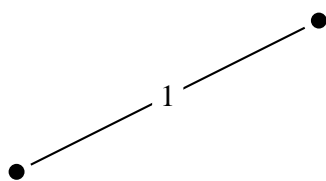

```
\cnode*(0,0){3pt}{A}
\cnode*(4,2){3pt}{B}
\ncline[nodesep=3pt]{A}{B}
\mput*{1}
```

Here is another:

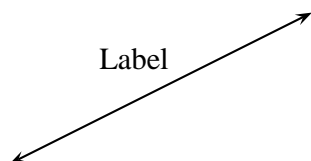

```
\pcline{<->}(0,0)(4,2)
\Aput{Label}
```

Now we can compare `\ncline` with `\ncLine`, and `\rnode` with `\Rnode`. First, here is a mathematical diagram with `\ncLine` and `\Rnode`:



```

\
\setlength{\arraycolsep}{1cm}
\def\tX{\tilde{\tilde{X}}}
\begin{array}{cc}
\lRnode{a}{(X-A,N-A)} & \lRnode{b}{(\tX,a)}\ll[1.5cm] \\
\lRnode{c}{(X,N)} & \lRnode{d}{\LARGE(\tX,N)}\ll[1.5cm] \\
\end{array}
\end{array}
\psset{nodesep=5pt,arrows=->}
\everypsbox{\scriptstyle}
\lncLine{a}{b}\Aput{a}
\lncLine{a}{c}\Bput{r}
\lncLine[linestyle=dashed]{c}{d}\Bput{b}
\lncLine{b}{d}\Bput{s}
\

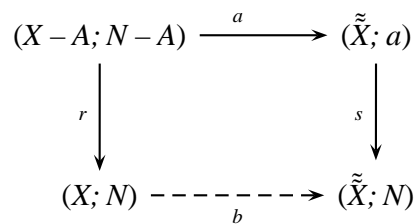
```

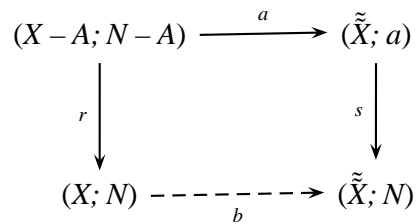

Here is the same one, but with `\ncline` and `\rnode` instead:



Driver notes: The node macros use `\pstVerb` and `\pstverbscale`.

VIII

Special Tricks

33 Coils and zigzags



The file `pst-coil.tex/pst-coil.sty` (and optionally the header file `pst-coil.pro`) defines the following graphics objects for coils and zigzags:

```
\pscoil*[par]{arrows}(x0,y0)(x1,y1)  
\psCoil*[par]{angle1}{angle2}  
\pszigzag*[par]{arrows}(x0,y0)(x1,y1)
```

These graphics objects use the following parameters:

coilwidth = <i>dim</i>	Default: 1cm
coilheight = <i>num</i>	Default: 1
coilarm = <i>dim</i>	Default: .5cm
coilaspect = <i>angle</i>	Default: 45
coilinc = <i>angle</i>	Default: 10

All coil and zigzag objects draw a coil or zigzag whose width (diameter) is **coilwidth**, and with the distance along the axes for each period (360 degrees) equal to

coilheight x coilwidth.

Both **\pscoil** and **\psCoil** draw a “3D” coil, projected onto the *xz*-axes. The center of the 3D coil lies on the *yz*-plane at angle **coilaspect** to the *z*-axis. The coil is drawn with PostScript’s `lineto`, joining points that lie at angle **coilinc** from each other along the coil. Hence, increasing **coilinc** makes the curve smoother but the printing slower. **\pszigzag** does not use the **coilaspect** and **coilinc** parameters.

\pscoil and **\pszigzag** connect (x_0, y_0) and (x_1, y_1) , starting and ending with straight line segments of length **coilarmA** and **coilarmB**, resp. Setting **coilarm** is the same as setting **coilarmA** and **coilarmB**.

Here is an example of **\pscoil**:

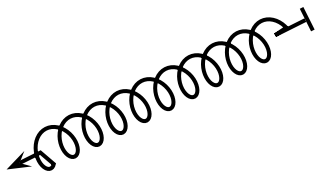

```
\pscoil[coilarm=.5cm,linewidth=1.5pt,coilwidth=.5cm]{<->}(4,2)
```

Here is an example of `\pszigzag`:



```
\pszigzag[coilarm=.5,linearc=.1]{<->}(4,0)
```

Note that `\pszigzag` uses the **linearc** parameters, and that the beginning and ending segments may be longer than **coilarm** to take up slack.

`\psCoil` just draws the coil horizontally from *angle1* to *angle2*. Use `\rput` to rotate and translate the coil, if desired. `\psCoil` does not use the **coilarm** parameter. For example, with **coilaspect=0** we get a sine curve:



```
\psCoil[coilaspect=0,coilheight=1.33,
coilwidth=.75,linewidth=1.5pt]{0}{1440}
```



pst-coil.tex also contains coil and zigzag node connections. You must also load pst-node.tex / pst-node.sty to use these. The node connections are:

```
\nccoil*[par]{arrows}{nodeA}{nodeB}
\nczigzag*[par]{arrows}{nodeA}{nodeB}
\pccoil*[par]{arrows}(x1,y1)(x2,y2)
\pczigzag*[par]{arrows}(x1,y1)(x2,y2)
```

The end points are chosen the same as for `\ncline` and `\pcline`, and otherwise these commands work like `\pscoil` and `\pszigzag`. For example:

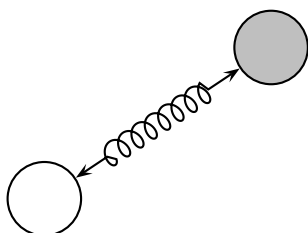

```
\cnode(.5,.5){.5}{A}
\cnode[fillstyle=solid,fillcolor=lightgray](3.5,2.5){.5}{B}
\nccoil[coilwidth=.3]{<->}{A}{B}
```

34 Special coordinates

The command

\SpecialCoor

enables a special feature that lets you specify coordinates in a variety of ways, in addition to the usual Cartesian coordinates.¹⁶ Processing is slightly slower and less robust, which is why this feature is available on demand rather than by default, but you probably won't notice the difference.

Here are the coordinates you can use:

(*x*,*y*) The usual Cartesian coordinate. E.g., (3,4).

(*r*;*a*) Polar coordinate, with radius *r* and angle *a*. The default unit for *r* is **unit**. E.g., (3;110).

(*node*) The center of *node*. E.g., (A).

([*par*]*node*) The position relative to *node* determined using the **angle**, **nodesep** and **offset** parameters. E.g., ([angle=45]A).

(!*ps*) Raw PostScript code. *ps* should expand to a coordinate pair. The units **xunit** and **yunit** are used. For example, if I want to use a polar coordinate (3; 110) that is scaled along with **xunit** and **yunit**, I can write

```
(!3 110 cos mul 3 110 sin mul)
```

(*coor1*|*coor2*) The *x* coordinate from *coor1* and the *y* coordinate from *coor2*. *coor1* and *coor2* can be any other coordinates for use with **\SpecialCoor**. For example, (A|1in;30).

\SpecialCoor also lets you specify angles in several ways:

num A number, as usual, with units given by the **\degrees** command.

¹⁶There is an obsolete command **\Polar** that causes coordinates in the form (*r*,*a*) to be interpreted as polar coordinates. The use of **\Polar** is not recommended because it does not allow one to mix Cartesian and polar coordinates the way **\SpecialCoor** does, and because it is not as apparent when examining an input file whether, e.g., (3,2) is a Cartesian or polar coordinate. The command for undoing **\Polar** is **\Cartesian**. It has an optional argument for setting the default units. I.e.,

```
\Cartesian(<x>,<y>)
```

has the effect of

```
\psset{xunit=<x>,yunit=<y>}
```

\Cartesian can be used for this purpose without using **\Polar**.

(*coord*) A coordinate, indicating where the angle points to. Be sure to include the (), in addition to whatever other delimiters the angle argument uses. For example, the following are two ways to draw an arc of .8 inch radius from 0 to 135 degrees:

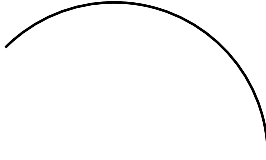

```
\SpecialCoord  
\psarc(0,0){.8in}{0}{135}  
\psarc(0,0){.8in}{0}{(-1,1)}
```

!ps Raw PostScript code. *ps* should expand to a number. The same units are used as with *num*.

The command

\NormalCoord

disables the **\SpecialCoord** features.

35 Overlays

Overlays are mainly of interest for making slides, and the overlay macros described in this section are mainly of interest to \TeX macro writers who want to implement overlays in a slide macro package. For example, the `seminar.sty` package, a \LaTeX style for notes and slides, uses `PSTricks` to implement overlays.

Overlays are made by creating an `\hbox` and then outputting the box several times, printing different material in the box each time. The box is created by the commands

\overlaybox *stuff*\endoverlaybox

\LaTeX users can instead write:

```
\begin{overlaybox} <stuff> \end{overlaybox}
```

The material for overlay *string* should go within the scope of the command

\psoverlay{*string*}

string can be any string, after expansion. Anything not in the scope of any `\psoverlay` command goes on overlay main, and material within the scope of `\psoverlay{all}` goes on all the overlays. `\psoverlay` commands can be nested and can be used in math mode.

The command

`\putoverlaybox{string}`

then prints overlay *string*.

Here is an example:

```
\overlaybox
  \psoverlay{all}
  \psframebox[framearc=.15,linewidth=1.5pt]{%
    \psoverlay{main}
    \parbox{3.5cm}{\raggedright
      Foam Cups Damage Environment {\psoverlay{one} Less than
        Paper Cups,} Study Says.}}
\endoverlaybox
  \putoverlaybox{main} \hspace{.5in} \putoverlaybox{one}
```

Foam Cups Damage
Environment

Study Says.

Less
than Paper Cups,

Driver notes: Overlays use `\pstVerb` and `\pstverbscale`.

36 The gradient fill style



The file `gradient.tex/gradient.sty`, along with the PostScript header file `gradient.pro`, defines the gradient **fillstyle**, for gradiated shading. This **fillstyle** uses the following parameters:

gradbegin=*color*

Default: gradbegin

The starting and ending color.

gradend=*color*

Default: gradend

The color at the midpoint.

gradlines=*int* **Default: 500**

The number of lines. More lines means finer gradiation, but slower printing.

gradmidpoint=*num* **Default: .9**

The position of the midpoint, as a fraction of the distance from top to bottom. *num* should be between 0 and 1.

gradangle=*angle* **Default: 0**

The image is rotated by *angle*.

gradbegin and **gradend** should preferably be rgb colors, but grays and cmyk colors should also work. The definitions of the colors **gradbegin** and **gradend** are:

```
\newrgbcolor{gradbegin}{0 .1 .95}
\newrgbcolor{gradend}{0 1 1}
```

Here are two ways to change the gradient colors:

```
\newrgbcolor{gradbegin}{1 .4 0}
```

and

```
\psset{gradbegin=blue}
```

Try this example:

```
\psframe[fillstyle=gradient,gradangle=45](10,-20)
```

37 Adding color to tables



The file `colortab.tex/colortab.sty` contains macros that, when used with color commands such as those in `PSTricks`, let you color the cells and lines in tables. See `colortab.doc` for more information.

38 Typesetting text along a path



The file `textpath.tex/textpath.sty` defines the command `\pstextpath`, for typesetting text along a path. It is a remarkable trick, but there are some caveats:

- `textpath.tex` only works with certain DVI-to-PS drivers. Here is what is currently known:
 - It works with Rokicki’s `dvips`, version 5.487 or later (at least up to v5.495).
 - It does not work with earlier versions of `dvips`.
 - It does not work with TeXview (to preview files with NeXT-TeX 3.0, convert the `.dvi` file to a PostScript file with `dvips -o` and use Preview).
 - “Does not work” means that it has no effect, for better or for worse.
 - This may work with other drivers. The requirement is that the driver only use PostScript’s `show` operator, `unbound` and `unloaded`, to show characters.
- You must also have installed the PostScript header file `textpath.ps`, and `\pstheader` must be properly defined in `pstricks.con` for your driver.
- Like other PSTricks that involve rotating text, this works best with PostScript (outline) fonts.
- PostScript rendering with `textpath.tex` is slow.

Because of all this, no samples are shown here. However, there is a test file `tp-test.tex` and PostScript output `tp-test.ps` that are distributed with PSTricks.

Here is the command:

`\pstextpath[pos](x,y){graphics object}{text}`

text is placed along the path, from beginning to end, defined by the PSTricks graphics object. (This object otherwise behaves normally. Set `linestyle=none` if you don’t want it to appear.)

text can only contain characters. No TeX rules, no PSTricks, and no other `\special`’s. (These things don’t cause errors; they just don’t work

right.) Math mode is OK, but math operators that are built from several characters (e.g., large integral signs) may break. Entire boxes (e.g., `\parbox`) are OK too, but this is mainly for amusement.

pos is either

- l justify on beginning of path
- c center on path
- r justify on end of path.

The default is l.

(x,y) is an offset. Characters are shifted distance x along path, and are shifted up by y . “Up” means with respect to the path, at whatever point on the path corresponding to the middle of the character. (x,y) must be Cartesian coordinates. Both coordinates use `\psunit` as the default. The default coordinate is $(0,\TPoffset)$, where `\TPoffset` a command whose default value is $-.7ex$. This value leads to good spacing of the characters. Remember that ex units are for the font in effect when `\pstextpath` occurs, not inside the *text* argument.

More things you might want to know:

- Like with `\rput` and the graphics objects, it is up to you to leave space for `\pstextpath`.
- Results are unpredictable if *text* is wider than length of path.
- `\pstextpath` leaves the typesetting to \TeX . It just intercepts the show operator to remap the coordinate system.

39 Stroking and filling character paths



The file `charpath.tex/charpath.sty` defines the command:

`\pscharpath*[par]{text}`

It strokes and fills the *text* character paths using the PSTricks **linestyle** and **fillstyle**.

The restrictions on DVI-to-PS drivers listed on page 76 for `\pstextpath` apply to `\pscharpath`. Furthermore, only outline (PostScript) fonts are affected.

Sample input and output files `chartest.tex` and `chartest.ps` are distributed with PSTricks.

With the optional `*`, the character path is not removed from the PostScript environment at the end. This is mainly for special hacks. For example, you can use `\pscharpath*` in the first argument of `\pstextpath`, and thus typeset text along the character path of some other text. See the sample file `denis1.tex`. (However, you cannot combine `\pscharpath` and `\pstextpath` in any other way. E.g., you cannot typeset character outlines along a path, and then fill and stroke the outlines with `\pscharpath`.)

The command

`\pscharclip*[par]{text} ... \endpscharclip`

works just like `\pscharpath`, but it also sets the clipping path to the character path. You may want to position this clipping path using `\rput` inside `\pscharclip`'s argument. Like `\psclip` and `\endpsclip`, `\pscharclip` and `\endpscharclip` should come on the same page and should be properly nested with respect to T_EX groups (unless `\AltClipMode` is in effect). The file `denis2.tex` contains a sample of `\pscharclip`.

40 Importing EPS files

PSTricks does not come with any facility for including Encapsulated PostScript files, because there are other very good and well-tested macros for exactly that. If using Rokicki's `dvips`, then try `epsf.tex/epsf.sty`, by the man himself!

What PSTricks *is* good for is embellishing your EPS picture. You can include an EPS file in the argument of `\rput`, as in

```
\rput(3,3){\epsfbox{myfile.eps}}
```

and hence you can include an EPS file in the `\pspicture` environment. Turn on `\psgrid`, and you can find the coordinates for whatever graphics or text you want to add. This works even when the picture has a weird bounding box, because with the arguments to `\pspicture` you control the bounding box from T_EX's point of view.

This isn't always the best way to work with an EPS file, however. If the PostScript file's bounding box is the size you want the resulting picture to be, after your additions, then try

```
\hbox{<picture objects> \epsfbox{<file.eps>}
```

This will put all your picture objects at the lower left corner of the EPS file. `\epsfbox` takes care of leaving the right amount of space.

If you need to determine the bounding box of an EPS file, then you can try of the automatic bounding box calculating programs, such as `bbfig` (distributed with Rokicki's `dvips`). However, all such programs are easily fooled; the only sure way to determine the bounding box is visually. `\psgrid` is a good tool for this.

41 Exporting EPS files



You must load `pst2eps.tex` or `pst2eps.sty` to use the `PSTricks` macros described in this section.

If you want to export an EPS file that contains both graphics and text, then you need to be using a DVI-to-PS driver that supports such a feature. If you just want to export pure graphics, then you can use the `\PSTricksEPS` command. Both of these options are described in this section.

Newer versions of Rokicki's `dvips` support an `-E` option for creating EPS files from `TEX` `.dvi` files. E.g.,

```
dvipsfoo:dvi -E -ofoo:eps
```

Your document should be a single page. `dvips` will find a tight bounding box that just encloses the printed characters on the page. This works best with outline (PostScript) fonts, so that the EPS file is scalable and resolution independent.

There are two inconvenient aspects of this method. You may want a different bounding box than the one calculated by `dvips` (in particular, `dvips` ignores all the PostScript generated by `PSTricks` when calculating the bounding box), and you may have to go out of your way to turn off any headers and footers that would be added by output routines.

`PSTricks` contains an environment that tries to get around these two problems:

```
\TeXtoEPS
```

```
stuff
```

```
\endTeXtoEPS
```

This is all that should appear in your document, but headers and whatever that would normally be added by output routines are ignored. `dvips` will again try to find a tight bounding box, but it will treat *stuff* as if there was a frame around it. Thus, the bounding box will be sure to include *stuff*, but might be larger if there is output outside the boundaries of this box. If the bounding box still isn't right, then you will have to edit the

```
%%BoundingBox <llx lly urx ury>
```

specification in the EPS file by hand.

If your goal is to make an EPS file for inclusion in other documents, then `dvips -E` is the way to go. However, it can also be useful to generate an EPS file from PSTricks graphics objects and include it in the same document,¹⁷ rather than just including the PSTricks graphics directly, because \TeX gets involved with processing the PSTricks graphics only when the EPS file is initially created or updated. Hence, you can edit your file and preview the graphics, without having to process all the PSTricks graphics each time you correct a typo. This speed-up can be significant with complex graphics such as `\pslistplot`'s with a lot of data.

To create an EPS file from PSTricks graphics objects, use

`\PSTtoEPS[par]{file}{graphics objects}`

The file is created immediately, and hence you can include it in the same document (after the `\PSTtoEPS` command) and as many times as you want. Unlike with `dvips -E`, only pure graphics objects are processed (e.g., `\rput` commands have no effect).

`\PSTtoEPS` cannot calculate the bounding box of the EPS file. You have to specify it yourself, by setting the following parameters:

<code>bbllx=dim</code>	Default: -1pt
<code>bbly=dim</code>	Default: -1pt
<code>bburx=dim</code>	Default: 1pt
<code>bbury=dim</code>	Default: 1pt

Note that if the EPS file is only to be included in a PSTricks picture with `\rput` you might as well leave the default bounding box.

`\PSTricksEPS` also uses the following parameters:

¹⁷See the preceding section on importing EPS files.

headerfile=*file*

Default: s

()This parameter is for specifying PostScript header files that are to be included in the EPS file. The argument should contain one or more file names, separated by commas. If you have more than one file, however, the entire list must be enclosed in braces {}.

headers=*none/all/user*

Default: none

When none, no header files are included. When all, the header files used by PSTricks plus the header files specified by the **headerfile** parameter are included. When user, only the header files specified by the **headerfile** parameter are included. If the EPS file is to be included in a T_EX document that uses the same PSTricks macros and hence loads the relevant PSTricks header files anyway (in particular, if the EPS file is to be included in the same document), then **headers** should be none or user.

Help

A Boxes

Many of the PSTricks macros have an argument for text that is processed in restricted horizontal mode (in \LaTeX parlance, LR-mode) and then transformed in some way. This is always the macro's last argument, and it is written *{stuff}* in this *User's Guide*. Examples are the framing, rotating, scaling, positioning and node macros. I will call these "LR-box" macros, and use framing as the leading example in the discussion below.

In restricted horizontal mode, the input, consisting of regular characters and boxes, is made into one (long or short) line. There is no line-breaking, nor can there be vertical mode material such as an entire displayed equation. However, the fact that you can include another box means that this isn't really a restriction.

For one thing, alignment environments such as `\halign` or \LaTeX 's `tabular` are just boxes, and thus present no problem. Picture environments and the box macros themselves are also just boxes. Actually, there isn't a single PSTricks command that cannot be put directly in the argument of an LR-box macro. However, entire paragraphs or other vertical mode material such as displayed equations need to be nested in a `\vbox` or \LaTeX `\parbox` or `minipage`. \LaTeX users should see `fancybox.sty` and its documentation, `fancybox.doc`, for extensive tips and trick for using LR-box commands.

The PSTricks LR-box macros have some features that are not found in most other LR-box macros, such as the standard \LaTeX LR-box commands.

With \LaTeX LR-box commands, the contents is always processed in text mode, even when the box occurs in math mode. PSTricks, on the other hand, preserves math mode, and attempts to preserve the math style as well. \TeX has four math styles: text, display, script and scriptscript. Generally, if the box macro occurs in displayed math (but not in sub- or superscript math), the contents are processed in display style, and otherwise the contents are processed in text style (even here the PSTricks macros can make mistakes, but through no fault of their own). If you don't get the right style, explicitly include a `\textstyle`, `\displaystyle`, `\scriptstyle` or `\scriptscriptstyle` command at the beginning of

the box macro's argument.

In case you want your PSTricks LR-box commands to treat math in the same as your other LR-box commands, you can switch this feature on and off with the commands

`\psmathboxtrue`
`\psmathboxfalse`

You can have commands (such as, but not restricted to, the math style commands) automatically inserted at the beginning of each LR-box using the

`\everypsbox{commands}`

command.¹⁸

If you would like to define an LR-box environment *name* from an LR-box command *cmd*, use

`\pslongbox{name}{cmd}`

For example, after

```
\pslongbox{MyFrame}{\psframebox}
```

you can write

```
MyFrame <stuff>\endMyFrame
```

instead of

```
\psframebox{<stuff>}
```

Also, \LaTeX users can write

```
\begin{MyFrame} <stuff>\end{MyFrame}
```

It is up to you to be sure that *cmd* is a PSTricks LR-box command; if it isn't, nasty errors can arise.

Environments like have nice properties:

¹⁸This is a token register.

- The syntax is clearer when *stuff* is long.
- It is easier to build composite LR-box commands. For example, here is a framed minipage environment for \LaTeX :

```
\pslongbox{MyFrame}{\psframebox}
\newenvironment{fminipage}%
  {\MyFrame\begin{minipage}}%
  {\end{minipage}\endMyFrame}
```

- You include verbatim text and other `\catcode` tricks in *stuff*.

The rest of this section elaborates on the inclusion of verbatim text in LR-box environments and commands, for those who are interested. `fancybox.sty` also contains some nice verbatim macros and tricks, some of which are useful for LR-box commands.

The reason that you cannot normally include verbatim text in an LR-box commands argument is that \TeX reads the whole argument before processing the `\catcode` changes, at which point it is too late to change the category codes. If this is all Greek to you,¹⁹ then just try this \LaTeX example to see the problem:

```
\psframebox{\verb+\foo{bar}+}
```

The LR-box environments defined with `\pslongbox` do not have this problem because *stuff* is not processed as an argument. Thus, this works:

```
\pslongbox{MyFrame}{\psframebox}
MyFrame \verb+\foo{bar}+\endMyFrame
```

\foo{bar}

The commands

`\psverbboxtrue`

`\psverbboxfalse`

switch into and out of, respectively, a special PSTricks mode that lets you include verbatim text in any LR-box command. For example:

¹⁹Incidentally, many foreign language macros, such as `greek.tex`, use `\catcode` tricks which can cause problems in LR-box macros.

```
\psverbboxtrue
\psframebox{\verb+\foo{bar}+}
```

```
\foo{bar}
```

However, this is not as robust. You must explicitly group color commands in *stuff*, and LR-box commands that usually ignore spaces that follow *{stuff}* might not do so when **\psverbboxtrue** is in effect.

B Tips and More Tricks

- 1 How do I rotate/frame this or that with \LaTeX ?

See `fancybox.sty` and its documentation.

- 2 How can I suppress the PostScript so that I can use my document with a non-PostScript dvi driver?

Put the command

\PSTricksOff

at the beginning of your document. You should then be able to print or preview drafts of your document (minus the PostScript, and perhaps pretty strange looking) with any dvi driver.

- 3 How can I improve the rendering of halftones?

This can be an important consideration when you have a halftone in the background and text on top. You can try putting

```
\pstverb{106 45 {dup mul exch dup mul add 1.0 exch sub} setscreen}
```

before the halftone, or in a header (as in headers and footers, not as in PostScript header files), if you want it to have an effect on every page.

`setscreen` is a device-dependent operator.

C Including PostScript code

To learn about the PostScript language, consult Adobe’s *PostScript Language Tutorial and Cookbook* (the “Blue Book”), or Henry McGilton and Mary Campione’s *PostScript by Example* (1992). Both are published by Addison-Wesley. You may find that the Appendix of the Blue Book, plus an understanding of how the stack works, is all you need to write simple code for computing numbers (e.g., to specify coordinates or plots using PostScript).

You may want to define \TeX macros for including PostScript fragments in various places. All \TeX macros are expanded before being passed on to PostScript. It is not always clear what this means. For example, suppose you write

```
\SpecialCoor
\def\mydata{23 43}
\psline(!47 \mydata add)
\psline(!47 \mydata\ add)
\psline(!47 \mydata~add)
\psline(!47 \mydata{} add)
```

You will get a PostScript error in each of the `\psline` commands. To see what the argument is expanding to, try use \TeX ’s `\edef` and `\show`. E.g.,

```
\def\mydata{23 43}
\edef\temp{47 \mydata add}
\show\temp
\edef\temp{47 \mydata\ add}
\show\temp
\edef\temp{47 \mydata~add}
\show\temp
\edef\temp{47 \mydata{} add}
\show\temp
```

\TeX expands the code, assigns its value to `\temp`, and then displays the value of `\temp` on your console. Hit *return* to procede. You will find that the four samples expand, respectively, to:

```
47 23 43add
47 23 43\ add
47 23 43\penalty \@M \ add
47 23 43{} add
```

All you really wanted was a space between the 43 and add. The command `\space` will do the trick:

```
\psline(!47 \mydata\space add)
```

You can include balance braces `{ }`; these will be passed on verbatim to PostScript. However, to include an unbalanced left or right brace, you have to use, respectively,

`\pslbrace`

`\psrbrace`

Don't bother trying `\}` or `\{`.

Whenever you insert PostScript code in a PSTricks argument, the dictionary on the top of the dictionary stack is `tx@Dict`, which is PSTricks's main dictionary. If you want to define your own variables, you have two options:

Simplest Always include a `@` in the variable names, because PSTricks never uses `@` in its variable names. You are at a risk of overflowing the `tx@Dict` dictionary, depending on your PostScript interpreter. You are also more likely to collide with someone else's definitions, if there are multiple authors contributing to the document.

Safest Create a dictionary named `TDict` for your scratch computations. Be sure to remove it from the dictionary stack at the end of any code you insert in an argument. E.g.,

```
TDict 10 dict def TDict begin <your code> end
```

D Troubleshooting

- 1 Why does the document bomb in the printer when the first item in a \LaTeX file is a float?

When the first item in a \LaTeX file is a float, `\special's` in the preamble are discarded. In particular, the `\special` for including PSTricks's header file is lost. The workaround is to put something before the float, or to include the header file by a command-line option with your dvi-to-ps driver.

- 2 I converted a .dvi file to PostScript, and then mailed it to a colleague. It prints fine for me but bombs on her printer.

Here is the most likely (but not the only) cause of this problem. The PostScript files you get when using PSTricks can contain long lines. This should be acceptable to any proper PostScript interpreter, but the lines can get chopped when mailing the file. There is no way to fix this in PSTricks, but you can make a point of wrapping the lines of your PostScript files when mailing them. E.g., on UNIX you can use uuencode and uudecode, or you can use the following AWK script to wrap the lines:

```
#!/bin/sh
# This script wraps all lines
# Usage (if script is named wrap):
#   wrap < infile > outfile
awk '
BEGIN {
    N = 78    # Max line length
}
{ if (length($0)<=N)
    print
  else {
    currlength = 0
    for (i = 1; i <=NF; i++) {
      if ((currlength = currlength + length($i) + 1) > N) {
        printf          printf          currlength = length($i)
      }
      else
        printf \ %s      }
      printf      }
    }
}'
```

- 3 The color commands cause extraneous vertical space to be inserted.

For example, this can happen if you start a \LaTeX `\parbox` or a `p{}` column with a color command. The solution usually is to precede the color command with `\leavevmode`.

- 4 The color commands interfere with other color macros I use.

Try putting the command `\altcolormode` at the beginning of your document. This may or may not help. Be extra careful that the scope of

color commands does not extend across pages. This is generally a less robust color scheme.

5 How do I stop floats from being the same color as surrounding material?

That's easy: Just put an explicit color command at the beginning of the float, e.g., **\black**.

6 When I use some color command in box macros or with `\setbox`, the colors get all screwed up.

If `\mybox` is a box register, and you write

```
\green Ho Hum.  
\setbox\mybox=\hbox{Foo bar \blue fee fum}  
Hi Ho. \red Diddle-dee  
\box\mybox hum dee do
```

then when `\mybox` is inserted, the current color is red and so `Foo bar` comes out red (rather than green, which was the color in effect when the box was set). The command that returns from **\blue** to the current color green, when the box is set, is executed after the `\hbox` is closed, which means that `Hi Ho` is green, but `hum dee do` is still blue.

This odd behavior is due to the fact that \TeX does not support color internally, the way it supports font commands. The first thing to do is to explicitly bracket any color commands inside the box. Second, be sure that the current color is black when setting the box. Third, make other explicit color changes where necessary if you still have problems. The color scheme invoked by **\altcolormode** is slightly better behaved if you follow the first two rules.

Note that various box macros use `\setbox` and so these anomalies can arise unexpectedly.

Index

- `\AltClipMode`, 55, 78
- `\altcolormode`, **88**, 89
- angle (parameter), **61**, 62, 63, 72
- angleA (parameter), 63–65
- angleB (parameter), 63, 64
- `\Aput`, **68**
- `\aput`, 67, **68**, 68
- arcangle (parameter), **61**
- arcangleA (parameter), 63
- arcangleB (parameter), 63
- arcsep (parameter), **13**
- arcsepA (parameter), **12**, 12, 13
- arcsepB (parameter), **12**, 13
- arm (parameter), **61**, 63
- armA (parameter), 63–65
- armB (parameter), 63–65
- arrowinset (parameter), **30**, 30
- arrowlength (parameter), **30**, 30
- `\arrows`, **40**
- arrows (parameter), 9, 11, 19, 20, **28**, 29, 48
- arrowscale (parameter), **30**, 30
- arrowsize (parameter), **30**
- axesstyle (parameter), **51**

- bbllx (parameter), **80**
- bbly (parameter), **80**
- bburx (parameter), **80**
- bbury (parameter), **80**
- `\black`, 89
- `\blue`, 89
- border (parameter), **25**, 25, 33, 62
- bordercolor (parameter), **25**, 25
- boxsep (parameter), **52**, 53, 54
- `\Bput`, **68**
- `\bput`, 67, **68**, 68
- bracketlength (parameter), **30**

- `\Cartesian`, **72**, 72
- `\circlenode`, **60**
- `\clipbox`, **54**
- `\closedshadow`, **38**

- `\closepath`, 34, **36**, 36
- `\cnode`, **60**
- `\cnodeput`, **60**
- `\code`, **39**, 40
- coilarm (parameter), **70**, 70, 71
- coilarmA (parameter), 70
- coilarmB (parameter), 70
- coilaspect (parameter), **70**, 70, 71
- coilheight (parameter), **70**, 70
- coilinc (parameter), **70**, 70
- coilwidth (parameter), **70**, 70
- `\coor`, **39**, 40
- cornersize (parameter), **10**, 10, 54
- `\cput`, **53**, 60
- curvature (parameter), **14**
- `\curveto`, **39**, 39

- dash (parameter), **25**
- dashed (parameter), 33
- `\dataplot`, **20**, 20, 21
- `\degrees`, **8**, 8, 72
- `\dim`, **39**
- dimen (parameter), **26**
- `\DontKillGlue`, **42**
- dotangle (parameter), **16**, 16
- dotscale (parameter), **16**
- dotsep (parameter), **25**
- dotsize (parameter), 16, **30**
- dotstyle (parameter), **16**, 16
- dotted (parameter), 33
- doublecolor (parameter), 25, **26**
- doubleline (parameter), **25**, 25, 26, 33
- doublesep (parameter), **25**, 25
- Dx (parameter), **49**, 49
- dx (parameter), **49**, 49
- Dy (parameter), **49**, 49
- dy (parameter), 49

- `\endoverlaybox`, **73**
- `\endpscharclip`, **78**, 78
- `\endpsclip`, **54**, 54, 55, 78
- `\endpspicture`, **41**

`\endTeXtoEPS`, **79**
`\everypsbox`, **83**

`\file`, **40**
`\fileplot`, **20**, **20**
`\fill`, **33**, **37**
`fillcolor` (parameter), **9**, **27**, **28**, **52**
`fillstyle` (parameter), **9**, **27**, **28**, **32**, **33**,
51, **74**, **77**
`framearc` (parameter), **10**, **10**
`\framenode`, **60**
`framesep` (parameter), **52**

`gradangle` (parameter), **75**
`gradbegin` (parameter), **74**, **75**
`gradend` (parameter), **74**, **75**
`gradlines` (parameter), **75**
`gradmidpoint` (parameter), **75**
`\gray`, **4**
`\grestore`, **37**, **37**, **38**
`gridcolor` (parameter), **18**
`griddots` (parameter), **18**, **18**
`gridlabelcolor` (parameter), **18**
`gridlabels` (parameter), **18**
`gridwidth` (parameter), **18**
`\gsave`, **37**, **37**, **38**

`hatchangle` (parameter), **27**, **27**
`hatchcolor` (parameter), **27**
`hatchsep` (parameter), **27**
`hatchwidth` (parameter), **27**
`headerfile` (parameter), **81**, **81**
`headers` (parameter), **81**, **81**

`\KillGlue`, **42**

`labels` (parameter), **50**
`labelsep` (parameter), **44**, **50**
`liftpen` (parameter), **35**, **35**, **37**
`linearc` (parameter), **10**, **10**, **19–21**, **54**,
63, **64**, **71**
`linecolor` (parameter), **8**, **8**, **9**, **24**, **28**,
32, **33**, **52**
`linestyle` (parameter), **24**, **25**, **28**, **32**,
33, **51**, **55**, **76**, **77**

`\lineto`, **39**, **39**
`linetype` (parameter), **33**, **33**
`linewidth` (parameter), **8**, **8**, **11**, **16**, **24**,
28–30, **32**, **33**
`\listplot`, **20**, **21**, **21**
`loopsize` (parameter), **62**, **65**
`\Lput`, **67**, **67**
`\lput`, **62**, **67**, **67**, **68**

`\movepath`, **38**
`\moveto`, **36**, **36**
`\Mput`, **67**, **67**
`\mput`, **68**
`\mrestore`, **38**, **38**
`\msave`, **38**, **38**
`\multido`, **47**, **51**
`\multips`, **46**, **46**, **51**
`\multirput`, **46**, **46**

`\ncangle`, **64**, **64**, **66**
`\ncangles`, **64**, **64**
`\ncarc`, **61**, **63**, **63**, **65**, **66**
`\ncbar`, **63**, **65**, **66**
`\nccircle`, **65**, **65**, **66**
`\nccoil`, **71**
`\nccurve`, **61**, **62**, **63**, **65**, **66**
`\ncdiag`, **63**, **64–66**
`\ncdiagg`, **64**, **66**
`\ncLine`, **62**, **65**, **68**
`\ncline`, **62**, **62**, **65**, **66**, **68**, **69**, **71**
`\ncloop`, **62**, **65**, **66**
`ncurv` (parameter), **61**, **62**, **63**
`\nczigzag`, **71**
`\newcmykcolor`, **5**
`\newgray`, **5**
`\newhsbcolor`, **5**
`\newpath`, **36**
`\newpsobject`, **31**, **31**, **54**
`\newpsstyle`, **31**, **31**
`\newrgbcolor`, **5**
`nodesep` (parameter), **61**, **62–64**, **72**
`nodesepA` (parameter), **65**
`\NormalCoor`, **73**

`offset` (parameter), **61**, **62–64**, **67**, **72**

`\openshadow`, **38**
`origin` (parameter), **24**, 33
`\ovalnode`, **60**
`\overlaybox`, **73**
`Ox` (parameter), **49**, 49, 50
`Oy` (parameter), **49**, 49, 50
`oy` (parameter), **49**, 49

`\parabola`, **14**, 14
parameters:
 `Dx`, **49**, 49
 `Dy`, **49**, 49
 `Ox`, **49**, 49, 50
 `Oy`, **49**, 49, 50
 `angleA`, 63–65
 `angleB`, 63, 64
 `angle`, **61**, 62, 63, 72
 `arcangleA`, 63
 `arcangleB`, 63
 `arcangle`, **61**
 `arcsepA`, **12**, 12, 13
 `arcsepB`, **12**, 13
 `arcsep`, **13**
 `armA`, 63–65
 `armB`, 63–65
 `arm`, **61**, 63
 `arrowinset`, **30**, 30
 `arrowlength`, **30**, 30
 `arrowscale`, **30**, 30
 `arrowsize`, **30**
 `arrows`, 9, 11, 19, 20, **28**, 29, 48
 `axesstyle`, **51**
 `bbllx`, **80**
 `bbly`, **80**
 `bburx`, **80**
 `bbury`, **80**
 `bordercolor`, **25**, 25
 `border`, **25**, 25, 33, 62
 `boxsep`, **52**, 53, 54
 `bracketlength`, **30**
 `coilarmA`, 70
 `coilarmB`, 70
 `coilarm`, **70**, 70, 71
 `coilaspect`, **70**, 70, 71

 `coilheight`, **70**, 70
 `coilinc`, **70**, 70
 `coilwidth`, **70**, 70
 `cornersize`, **10**, 10, 54
 `curvature`, **14**
 `dashed`, 33
 `dash`, **25**
 `dimen`, **26**
 `dotangle`, **16**, 16
 `dotscale`, **16**
 `dotsep`, **25**
 `dotsize`, 16, **30**
 `dotstyle`, **16**, 16
 `dotted`, 33
 `doublecolor`, 25, **26**
 `doubleline`, **25**, 25, 26, 33
 `doublesep`, **25**, 25
 `dx`, **49**, 49
 `dy`, 49
 `fillcolor`, 9, **27**, 28, 52
 `fillstyle`, 9, **27**, 28, 32, 33, 51, 74, 77
 `framearc`, **10**, 10
 `framesep`, **52**
 `gradangle`, **75**
 `gradbegin`, **74**, 75
 `gradend`, **74**, 75
 `gradlines`, **75**
 `gradmidpoint`, **75**
 `gridcolor`, **18**
 `griddots`, **18**, 18
 `gridlabelcolor`, **18**
 `gridlabels`, **18**
 `gridwidth`, **18**
 `hatchangle`, **27**, 27
 `hatchcolor`, **27**
 `hatchsep`, **27**
 `hatchwidth`, **27**
 `headerfile`, **81**, 81
 `headers`, **81**, 81
 `labelsep`, **44**, 50
 `labels`, **50**
 `liftpen`, **35**, 35, 37

linearc, **10**, 10, 19–21, 54, 63, 64, 71
 linecolor, **8**, 8, 9, 24, 28, 32, 33, 52
 linestyle, **24**, 25, 28, 32, 33, 51, 55, 76, 77
 linetype, **33**, 33
 linewidth, **8**, 8, 11, 16, 24, 28–30, 32, 33
 loopsz, **62**, 65
 ncurv, **61**, 62, 63
 nodesepA, 65
 nodesep, **61**, 62–64, 72
 offset, **61**, 62–64, 67, 72
 origin, **24**, 33
 oy, **49**, 49
 plotpoints, **22**, 22
 plotstyle, **19**, 19, 34
 pspicture, 41
 rbracketlength, **30**
 rectorc, 54
 runit, **7**, 8
 shadowangle, **26**, 26
 shadowcolor, **26**, 26
 shadowsize, **26**, 26, 53
 shadow, **26**, 26, 33
 showorigin, **50**
 showpoints, **9**, 12, 14–16, 19–21, 33
 style, 31
 subgridcolor, **18**
 subgriddiv, **18**
 subgriddots, **18**
 subgridwidth, **18**
 swapaxes, **24**, 33
 tbarsize, 16, **30**
 ticksize, **50**
 tickstyle, **50**, 50
 ticks, **50**
 unit, **7**, 7, 19, 72
 xunit, **7**, 8, 17, 18, 72
 yunit, **7**, 7, 8, 17, 18, 72
 \parametricplot, **22**, 22, 23
 \pcangle, **66**
 \pcarc, **65**
 \pcbar, **65**
 \pccoil, **71**
 \pccurve, 61, **65**
 \pcdiag, **65**
 \pcline, **65**, 67, 71
 \pcloop, 62, **66**
 \pczigzag, **71**
 \plotfile, 20
 plotpoints (parameter), **22**, 22
 plotstyle (parameter), **19**, 19, 34
 \pnode, **60**
 \Polar, **72**, 72
 \psaddtolength, **7**
 \psarc, **12**, 12, 13, 61
 \psarcn, **13**, 13
 \psaxes, 17, **48**, 49–51
 \psbezier, **13**, 13, 34, 35
 \psborder, 25
 \psccurve, **15**, 19
 \pscharclip, **78**, 78
 \pscharpath, **77**, 78
 \pscircle, **11**, 26
 \pscircle*, 11
 \pscirclebox, 52, **53**, 53, 60
 \psclip, **54**, 54, 55, 78
 \psCoil, **70**, 70, 71
 \pscoil, **70**, 70, 71
 \pscurve, **15**, 15, 19, 34, 37
 \pscustom, 13, **32**, 32–34, 36, 37, 39, 46, 54, 61
 \psdblframebox, **53**, 60
 \psdots, **15**, 19, 34
 \pscurve, **15**, 19
 \psellipse, **12**, 26
 \psfill, 32
 \psframe, 9, 10, **11**, 11, 26, 51, 52
 \psframebox, **52**, 52–54, 60
 \psgrid, **17**, 17–19, 34, 48, 78, 79
 \ps hatchcolor, 27
 \pslabelsep, **44**, 50, 68
 \pslbrace, **87**
 \psline, 7, **10**, 10, 11, 19, 22, 31, 34, 51, 65, 86

`\pslinecolor`, 8
`\pslinewidth`, 8
`\pslongbox`, **83**, 84
`\psmathboxfalse`, **83**
`\psmathboxtrue`, **83**
`\psovalbox`, 52, **54**, 60
`\psoverlay`, **73**, 74
`\pspicture`, 17, **41**, 41, 42, 54, 78
`pspicture` (parameter), 41
`\psplot`, **21**, 21–23
`\pspolygon`, 10, **11**, 19, 28
`\psrbrace`, **87**
`\psrunit`, 8
`\psset`, 5, **6**, 6, 11, 41
`\pssetlength`, **7**
`\psshadowbox`, **53**, 60
`\pstextpath`, **76**, 76, 77
`\pstheader`, 76
`\PSTricksEPS`, 79, 80
`\PSTricksOff`, **85**
`\pstroke`, 32
`\pstrotate`, 46
`\PSTtoEPS`, 20, **80**, 80
`\pstunit`, 32
`\pstVerb`, 5, 42, 46, 55, 69, 74
`\pstverb`, 32
`\pstverbscale`, 42, 55, 69, 74
`\psunit`, 8, 77
`\psverbboxfalse`, **84**
`\psverbboxtrue`, 4, **84**, 85
`\pswedge`, **12**, 26
`\psxlabel`, **51**
`\psxunit`, 8, 19
`\psylabel`, **51**
`\psyunit`, 8, 19
`\pszigzag`, **70**, 70, 71
`\putoverlaybox`, **74**

`\qdisk`, **11**, 34
`\qline`, **10**, 34

`\radians`, **8**
`rbracketlength` (parameter), **30**
`\rcoor`, **40**

`\rcurveto`, **39**
`\readdata`, **20**, 20, 21
`rectarc` (parameter), 54
`\red`, 4
`\rlineto`, **39**
`\Rnode`, **59**, 60, 68
`\rnode`, **59**, 59, 60, 68, 69
`\RnodeRef`, **59**, 60
`\rotate`, **38**
`\Rotatedown`, 56
`\rotatedown`, **56**
`\rotateleft`, **55**
`\rotateright`, **55**
`\Rput`, **45**, 45, 67
`\rput`, 41, **43**, 43–46, 53, 58, 67, 71, 78, 80
`runit` (parameter), **7**, 8

`\savedata`, **20**, 20
`\scale`, **38**
`\scalebox`, **56**
`\scaleboxto`, **56**
`\setcolor`, **40**
`shadow` (parameter), **26**, 26, 33
`shadowangle` (parameter), **26**, 26
`shadowcolor` (parameter), **26**, 26
`shadowsize` (parameter), **26**, 26, 53
`showorigin` (parameter), **50**
`showpoints` (parameter), **9**, 12, 14–16, 19–21, 33
`\SpecialCoor`, 7, 8, **72**, 72, 73
`\stroke`, 33, **36**
`style` (parameter), 31
`subgridcolor` (parameter), **18**
`subgriddiv` (parameter), **18**
`subgriddots` (parameter), **18**
`subgridwidth` (parameter), **18**
`\swapaxes`, **38**
`swapaxes` (parameter), **24**, 33

`tbarsize` (parameter), 16, **30**
`\TeXtoEPS`, **79**
`ticks` (parameter), **50**
`ticksize` (parameter), **50**

tickstyle (parameter), **50**, 50

\TPoffset, 77

\translate, **38**

unit (parameter), **7**, 7, 19, 72

\uput, **44**, 44, 45, 68

xunit (parameter), **7**, 8, 17, 18, 72

yunit (parameter), **7**, 7, 8, 17, 18, 72

1 Dots

The graphics objects

`\psdot*[par](x1,y1)`

`\psdots*[par](x1,y1)(x2,y2)...(xn,yn)`

put a dot at each coordinate.

What a “dot” is depends on the value of the

dotstyle=style

Default: *

parameter. This also determines the dots you get when **showpoints=true**.

The dot styles are also pretty intuitive:

<i>Style</i>	<i>Example</i>	<i>Style</i>	<i>Example</i>
*	• • • • •	square	◻ ◻ ◻ ◻ ◻
o	◦ ◦ ◦ ◦ ◦	square*	◼ ◼ ◼ ◼ ◼
+	+ + + + +	diamond	◊ ◊ ◊ ◊ ◊
x	× × × × ×	diamond*	◈ ◈ ◈ ◈ ◈
asterisk	* * * * *	triangle	▲ ▲ ▲ ▲ ▲
oplus	⊕ ⊕ ⊕ ⊕ ⊕	triangle*	▴ ▴ ▴ ▴ ▴
otimes	⊗ ⊗ ⊗ ⊗ ⊗	pentagon	◊ ◊ ◊ ◊ ◊
		pentagon*	◆ ◆ ◆ ◆ ◆

Except for diamond, the center of dot styles with a hollow center is colored **fillcolor**.

Here are the parameters for changing the size and orientation of the dots:

dotsize=dim ‘num’

Default: 2pt 2

The diameter of a circle or disc is *dim* plus *num* times **linewidth** (if the optional *num* is included). The size of the other dots styles is similar (except for the size of the | dot style, which is set by the **tbar** parameter described on page ??).

dotscale=num1 ‘num2’

Default: 1

The dots are scaled horizontally by *num1* and vertically by *num2*. If you only include *num1*, the arrows are scaled by *num1* in both directions.

dotangle=*angle*

Default: 0

After setting the size and scaling the dots, the dots are rotated by *angle*.

2 Arrowheads and such

New arrows:

<i>Value</i>	<i>Example</i>	<i>Name</i>
<->	←→	T-bars and arrowheads.
<*-> *	←→	T-bars and arrowheads, flush.

The size of these line terminators is controlled by the following parameters. In the description of the parameters, the width always refers to the dimension perpendicular to the line, and length refers to a dimension in the direction of the line.

arrowsize=*dim 'num'*

Default: 1.5pt 2

The width of arrowheads is *dim* plus *num* times **linewidth** (if the optional 'num' is included). See the diagram below.

arrowlength=*num*

Default:

Length of arrowheads, as a fraction of the width, as shown below.

arrowinset=*num*

Default:

Size of inset for arrowheads, as a fraction of the length, as shown below.

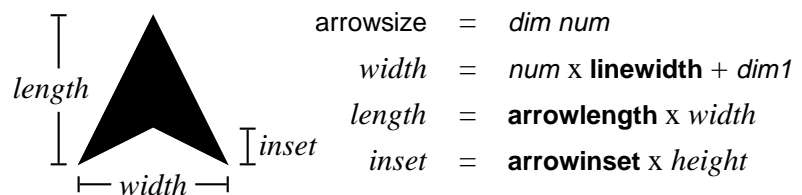

tbarsize=*dim 'num'*

Default:

The width of a t-bar, square bracket or rounded bracket is *dim* plus *num* times **linewidth** (if the optional 'num' is included).

bracketlength=*num*

Default:

The height of a square bracket is *num* times its width.

rbracketlength=num

Default:

The height of a round bracket is *num* times its width.

arrowscale=arrowscale=num1 'num2'

Default:

Imagine that arrows and such point down. This scales the width of the arrows by *num1* and the length (height) by *num2*. If you only include one number, the arrows are scaled the same in both directions. Changing **arrowscale** can give you special effects not possible by changing the parameters described above. E.g., you can change the width of lines used to draw brackets.

The size of dots is controlled by the **dotsize** parameter.

3 Lines and polygons

\psdiamond*[par](x0,y0)(x1,y1)

\psdiamond draws a diamond centered at $(x0,y0)$, and with the half width and height equal to $x1$ and $y1$, respectively.

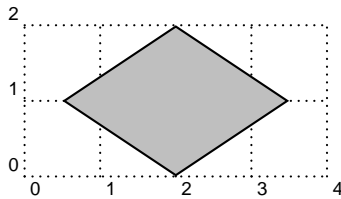

```
\psdiamond[framearc=.3,fillstyle=solid,  
fillcolor=lightgray](2,1)(1.5,1)
```

The diamond is rotated about the center by

gangle=gangle

Default: 0

\pstriangle*[par](x0,y0)(x1,y1)

\pstriangle draws an isosceles triangle with the base centered at $(x0,y0)$, and with width (base) and height equal to $x1$ and $y1$, respectively.

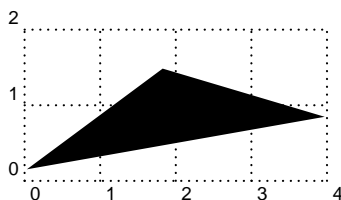

```
\pstriangle*[gangle=10](2,.5)(4,1)
```

4 Framed boxes

`\psdiabox*[par]{stuff}`

`\psdiabox` draws a diamond.



`\psdiabox[shadow=true]{\Large\bf Happy?}`

`\pstribox*[par]{stuff}`

`\pstribox` draws a triangle.

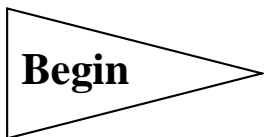

`\pstribox[trimode=R,framesep=5pt]{\Large\bf Begin}`

The triangle points in the direction:

trimode=**U/D/R/L*

Default: U

If you include the optional ***, then an equilateral triangle is drawn, otherwise, you get the minimum-area isosceles triangle.

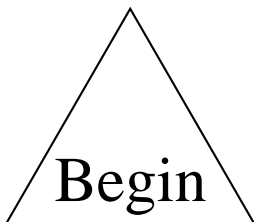

`\pstribox[trimode=*U]{\Huge Begin}`

5 Obsolete put commands

There is an obsolete command `\Rput` that has the same syntax as `\uput` and that works almost the same way, except the *refangle* argument has the syntax of `\rput`'s *refpoint* argument, and it gives the point in *stuff* that should be aligned with (x,y) . E.g.,

`\qdisk(4,0){2pt}` •
`\Rput[tl](4,0){(x,y)}` (x; y)

Here is the equivalence between `\uput`'s *refangle* abbreviations and `\Rput`'s *refpoint* abbreviations:

\uput r u l d ur ul dr dl
\Rput l b r t bl br tr rl

Some people prefer **\Rput**'s convention for specifying the position of *stuff* over **\uput**'s.

Once upon a time there was `\psput` instead of **\uput**. This feature is still supported for backwards compatibility.

Nodes and Node Connections



All the commands described in this part are contained in the file `pst-node.tex/pst-node.sty`.

The node and node connection macros let you connect information and place labels, without knowing the exact position of what you are connecting or where the lines should connect. These macros are useful for making graphs and trees, mathematical diagrams, linguistic syntax diagrams, and connecting ideas of any kind. They are the trickiest tricks in PSTricks!

There are three components to the node macros:

Node definitions The node definitions let you assign a name and shape to an object. See Section 6.

Node connections The node connections connect two nodes, identified by their names. See Section 7.

Node labels The node label commands let you affix labels to the node connections. See Section 8.

You can use these macros just about anywhere. The best way to position them depends on the application. For greatest flexibility, you can use the nodes in a `\pspicture`, positioning and rotating them with `\rput`. You can also use them in alignment environments. `pst-node.tex` contains a special alignment environment, `\psmatrix`, which is designed for positioning nodes in a grid, such as in mathematical diagrams and some graphs. `\psmatrix` is described in Section ???. `pst-node.tex` also contains high-level macros for trees. These are described in Part ???.

But don't restrict yourself to these more obvious uses. For example:

I made the file symbol a node. Now I can draw an arrow so that you know what I am talking about.

```
\node{A}{%
  \parbox{4cm}{\raggedright
    I made the file symbol a node. Now I can draw an
    arrow so that you know what I am talking about.}}
\ncarc[nodesep=8pt]{->}{A}{file}
```

6 Nodes



Nodes have a name, a boundary and a center.

The name is for referring to the node when making node connections and labels. You specify the name as an argument to the node commands. The name must contain only letters and numbers, and must begin with a letter. Bad node names can cause PostScript errors.

The center of a node is where node connections point to. The boundary is for determining where to connect a node connection. The various nodes differ in how they determine the center and boundary. They also differ in what kind of visible object they create.

Here are the nodes:

`\rnode[refpoint]{name}{stuff}`

`\rnode` puts *stuff* in a box. The center of the node is *refpoint*, which you can specify the same way as for `\rput`.

`\Rnode*[par]{name}{stuff}`

`\Rnode` also makes a box, but the center is set differently. If you align `\rnode`'s by their baseline, differences in the height and depth of the nodes can cause connecting lines to be not quite parallel, such as in the following example:

sp ————— Bit

```
\Large
\rnode{A}{sp} \hspace 2cm \rnode{B}{Bit}
\inclined{A}{B}
```

With `\Rnode`, the center is determined relative to the baseline:

sp ————— Bit

```
\Large
\Rnode{A}{sp} \hspace 2cm \Rnode{B}{Bit}
\inclined{A}{B}
```

You can usually get by without fiddling with the center of the node, but to modify it you set the

`href=num`
`vref=dim`

Default: 0
Default: .7ex

parameters. In the horizontal direction, the center is located fraction **`href`** from the center to the edge. E.g, if **`href=-1`**, the center is on the left edge of the box. In the vertical direction, the center is located distance **`vref`** from the baseline. The **`vref`**

parameter is evaluated each time `\Rnode` is used, so that you can use ex units to have the distance adjust itself to the size of the current font (but without being sensitive to differences in the size of letters within the current font).

`\pnode(x,y){name}`

This creates a zero dimensional node at (x,y).

`\cnode*[par](x,y){radius}{name}`

This draws a circle. Here is an example with `\pnode` and `\cnode`:

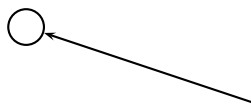

```
\cnode(0,1){.25}{A}
\pnode(3,0){B}
\cline{<-}{A}{B}
```

`\Cnode*[par](x,y){name}`

This is like `\cnode`, but the radius is the value of

radius=dim

Default: 2pt

This is convenient when you want many circle nodes of the same radius.

`\circlenode*[par]{name}{stuff}`

This is a variant of `\pscirclebox` that gives the node the shape of the circle.

`\cnodeput*[par]{angle}(x,y){name}{stuff}`

This is a variant of `\cput` that gives the node the shape of the circle. That is, it is like

```
\rput{angle}(x,y){\circlenode{name}{stuff}}
```

`\ovalnode*[par]{name}{stuff}`

This is a variant of `\psovalbox` that gives the node the shape of an ellipse. Here is an example with `\circlenode` and `\ovalnode`:

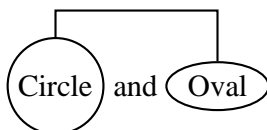

```
\circlenode{A}{Circle} and \ovalnode{B}{Oval}
\ncbar[angle=90]{A}{B}
```

`\dianode*[par]{name}{stuff}`

This is like `\diabox`.

`\trinode*[par]{name}{stuff}`

This is like `\tribox`.

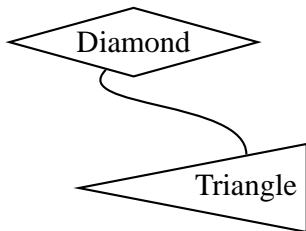

```
\rput[tl](0,3){\dianode{A}{Diamond}}
\rput[br](4,0){\trinode[trimode=L]{B}{Triangle}}
\ncurve[angleA=-135,angleB=90]{A}{B}
```

`\dotnode*[par](x,y){name}`

This is a variant of `\psdot`. For example:

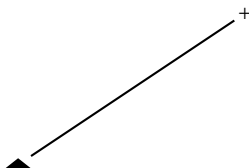

```
\dotnode[dotstyle=triangle*,dotstyle=2 1](0,0){A}
\dotnode[dotstyle=+](3,2){B}
\ncurve[nodesep=3pt]{A}{B}
```

`\fnode*[par](x,y){name}`

The `f` stands for “frame”. This is like, but easier than, putting a `\psframe` in an `\node`.

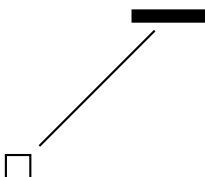

```
\fnode{A}
\fnode*[framesize=1 5pt](2,2){B}
\ncurve[nodesep=3pt]{A}{B}
```

There are two differences between `\fnode` and `\psframe`:

- There is a single (optional) coordinate argument, that gives the *center* of the frame.
- The width and height of the frame are set by the

`framesize=dim1 ‘dim2’` **Default: 10pt**

parameter. If you omit *dim2*, you get a square frame.

7 Node connections

All the node connection commands begin with `nc`, and they all have the same syntax:¹

¹The node connections can be used with `\pscustom`. The beginning of the node connection is attached to the current point by a straight line, as with `\psarc`.²

`\nodeconnection[par]{arrows}{nodeA}{nodeB}`

A line of some sort is drawn from *nodeA* to *nodeB*. Some of the node connection commands are a little confusing, but with a little experimentation you will figure them out, and you will be amazed at the things you can do. When we refer to the A and B nodes below, we are referring only to the order in which the names are given as arguments to the node connection macros.³

The node connections use many of the usual graphics parameters, plus a few special ones. Let's start with one that applies to all the node connections:

nodesep=dim

Default: 0pt

nodesep is the border around the nodes that is added for the purpose of determining where to connect the lines.

For this and other node connection parameters, you can set different values for the two ends of the node connection. Set the parameter **nodesepA** for the first node, and set **nodesepB** for the second node.

The first two node connections draw a line or arc directly between the two nodes:

\incline*[par]{arrows}{nodeA}{nodeB}

This draws a straight line between the nodes. For example:

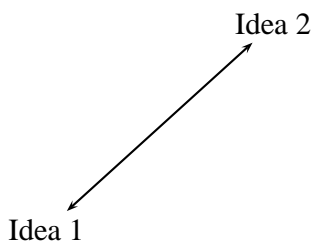

```
\rput[bl](0,0){\rnode{A}{Idea 1}}
\rput[tr](4,3){\rnode{B}{Idea 2}}
\incline[nodesep=3pt]{<->}{A}{B}
```

\incarc*[par]{arrows}{nodeA}{nodeB}

This connects the two nodes with an arc.

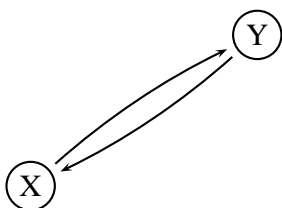

```
\cnodeput(0,0){A}{X}
\cnodeput(3,2){B}{Y}
\psset{nodesep=3pt}
\incarc{->}{A}{B}
\incarc{->}{B}{A}
```

³When a node name cannot be found on the same page as the node connection command, you get either no node connection or a nonsense node connection. However, T_EX will not report any errors.

The angle between the arc and the line between the two nodes is⁴

arcangle=angle **Default: 8**

\ncline and **\ncarc** both determine the angle at which the node connections join by the relative position of the two nodes. With the next group of node connections, you specify one or both of the angles in absolute terms, by setting the

angle=angle **Default: 0**

(and **angleA** and **angleB**) parameter.

You also specify the length of the line segment where the node connection joins at one or both of the ends (the “arms”) by setting the

arm=dim **Default: 10pt**

(and **armA** and **armB**) parameter.

These node connections all consist of several line segments, including the arms. The value of **linearc** is used for rounding the corners.

Here they are, starting with the simplest one:

\ncdiag*[par]{arrows}{nodeA}{nodeB}

An arm is drawn at each node, joining at angle **angleA** or **angleB**, and with a length of **armA** or **armB**. Then the two arms are connected by a straight line, so that the whole line has three line segments. For example:

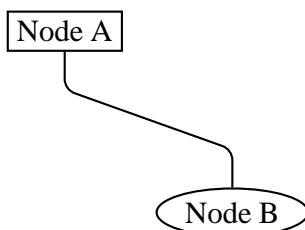

```
\rput[tl](0,3){\rnode{A}{\psframebox{Node A}}}  
\rput[br](4,0){\ovalnode{B}{Node B}}  
\ncdiag[angleA=-90, angleB=90, arm=.5, linearc=.2]{A}{B}
```

⁴Rather than using a true arc, **\ncarc** actually draws a bezier curve. When connecting two circular nodes using the default parameter values, the curve will be indistinguishable from a true arc. However, **\ncarc** is more flexible than an arc, and works right connecting nodes of different shapes and sizes. You can set **arcangleA** and **arcangleB** separately, and you can control the curvature with the **ncurv** parameter, which is described on page ??.

You can also set one or both of the arms to zero length. For example, if you set **arm=0**, the nodes are connected by a straight line, but you get to determine where the line connects (whereas the connection point is determined automatically by **\ncline**). Compare this use of **\ncdiag** with **\ncline** in the following example:

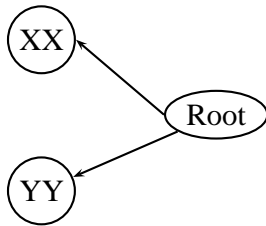

```
\rput[r](4,1){\ovalnode{R}{Root}}
\ncodeput(1,2){A}{XX}
\ncodeput(1,0){B}{YY}
\ncdiag[angleB=180, arm=0]{<-}{A}{R}
\ncline{<-}{B}{R}
```

(Note that in this example, the default value **angleA=0** is used.)

\ncdiagg*[par]{arrows}{nodeA}{nodeB}

\ncdiagg is similar to **\ncdiag**, but only the arm for node A is drawn. The end of this arm is then connected directly to node B. Compare **\ncdiagg** with **\ncdiag** when **armB=0**:

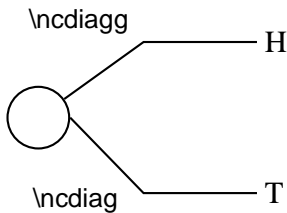

```
\ncode(0,0){12pt}{a}
\rput[l](3,1){\rnode{b}{H}}
\rput[l](3,-1){\rnode{c}{T}}
\ncdiagg[angleA=180, armA=1.5, nodesepA=3pt]{b}{a}
\ncdiag[angleA=180, armA=1.5, armB=0, nodesepA=3pt]{c}{a}
```

You can use **\ncdiagg** with **armA=0** if you want a straight line that joins to node A at the angle you specify, and to node B at an angle that is determined automatically.

\ncbar*[par]{arrows}{nodeA}{nodeB}

This node connection consists of a line with arms dropping “down”, at right angles, to meet two nodes at an angle **angleA**. Each arm is at least of length **armA** or **armB**, but one may be need to be longer.

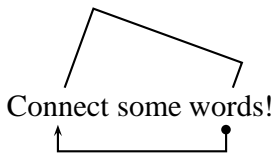

```
\rnode{A}{Connect} some \rnode{B}{words}!
\ncbar[nodesep=3pt,angle=-90]{<-*}{A}{B}
\ncbar[nodesep=3pt,angle=70]{A}{B}
```

Generally, the whole line has three straight segments.

\ncangle**[par]{arrows}{nodeA}{nodeB}*

Now we get to a more complicated node connection. **\ncangle** typically draws three line segments, like **\ncdiag**. However, rather than fixing the length of arm A, we adjust arm A so that the line joining the two arms meets arm A at a right angle. For example:

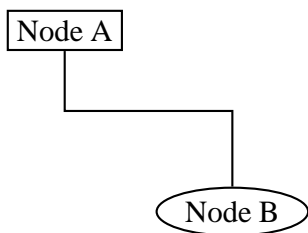

```
\rput[tl](0,3){\node{A}{\psframebox{Node A}}}  
\rput[br](4,0){\ovalnode{B}{Node B}}  
\ncangle[angleA=-90,angleB=90,armB=1cm]{A}{B}
```

Now watch what happens when we change **angleA**:

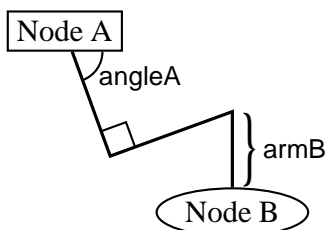

```
\rput[tl](0,3){\node{A}{\psframebox{Node A}}}  
\rput[br](4,0){\ovalnode{B}{Node B}}  
\ncangle[angleA=-70,angleB=90,armB=1cm,linewidth=1.2pt]{A}{B}
```

\ncangle is also a good way to join nodes by a right angle, with just two line segments, as in this example:

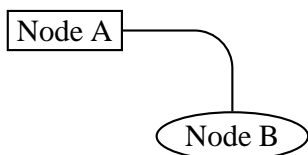

```
\rput[tl](0,2){\node{A}{\psframebox{Node A}}}  
\rput[br](4,0){\ovalnode{B}{Node B}}  
\ncangle[angleB=90, armB=0, linearc=.5]{A}{B}
```

\ncangles**[par]{arrows}{nodeA}{nodeB}*

\ncangles is similar to **\ncangle**, but the length of arm A is fixed by the **armA** parameter. Arm A is connected to arm B by two line segments that meet arm A and each other at right angles. The angle at which they join arm B, and the length of the connecting segments, depends on the positions of the two arms. **\ncangles** generally draws a total of four line segments.⁵ For example:

⁵Hence there is one more angle than **\ncangle**, and hence the s in **\ncangles**.

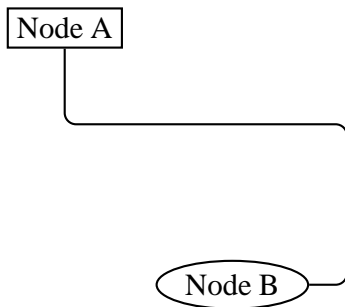

```
\rput[tl](0,4){\node{A}{\psframebox{Node A}}}
\rput[br](4,0){\ovalnode{B}{Node B}}
\ncangles[angleA=-90, armA=1cm, armB=.5cm, linearc=.15]{A}{B}
```

Let's see what happens to the previous example when we change **angleB**:

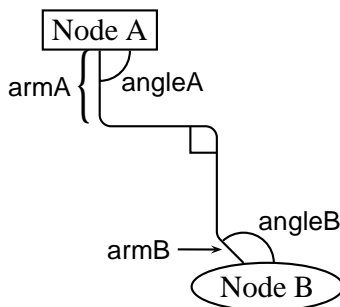

```
\rput[tl](0,4){\node{A}{\psframebox{Node A}}}
\rput[br](4,0){\ovalnode{B}{Node B}}
\ncangles[angleA=-90, angleB=135, armA=1cm, armB=.5cm,
linearc=.15]{A}{B}
```

\ncloop[par]{arrows}{nodeA}{nodeB}***

\ncloop is also in the same family as **\ncangle** and **\ncangles**, but now typically 5 line segments are drawn. Hence, **\ncloop** can reach around to opposite sides of the nodes. The lengths of the arms are fixed by **armA** and **armB**. Starting at arm A, **\ncloop** makes a 90 degree turn to the left, drawing a segment of length

loopsize=dim

Default: 1cm

This segment connects to arm B the way arm A connects to arm B with **\ncline**; that is, two more segments are drawn, which join the first segment and each other at right angles, and then join arm B. For example:

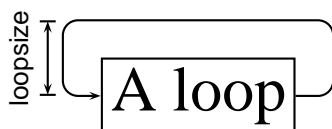

```
\node{a}{\psframebox{\Huge A loop}}
\ncloop[angleB=180,loopsize=1,arm=.5,linearc=.2]{->}{a}{a}
```

In this example, node A and node B are the same node! You can do this with all the node connections (but it doesn't always make sense).

Here is an example where **\ncloop** connects two different nodes:

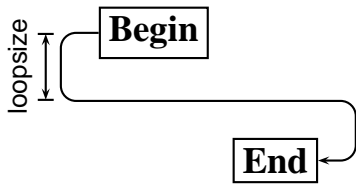

```
\parbox{3cm}{%
\node{A}{\psframebox{\large\bf Begin}}
\vspace{1cm}\hspace*{\fill}
\node{B}{\psframebox{\large\bf End}}
\ncloop[angleA=180,loopsize=.9,arm=.5,linearc=.2]{->}{A}{B}}
```

The next two node connections are a little different from the rest.

\ncurve*[*par*]{*arrows*}{*nodeA*}{*nodeB*}

\ncurve draws a bezier curve between the nodes.

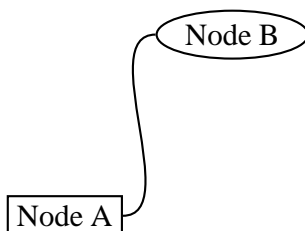

```
\rput[bl](0,0){\node{A}{\psframebox{Node A}}}
\rput[tr](4,3){\ovalnode{B}{Node B}}
\ncurve[angleB=180]{A}{B}
```

You specify the angle at which the curve joins the nodes by setting the **angle** (and **angleA** and **angleB**) parameter. The distance to the control points is set with the

ncurv=num

Default: .67

(and **ncurvA** and **ncurvB**) parameter. A lower number gives a tighter curve. (The distance between the beginning of the arc and the first control point is one-half **ncurvA** times the distance between the two endpoints.)

\nccircle*[*par*]{*arrows*}{*node*}{*radius*}

\nccircle draws a circle, or part of a circle, that, if complete, would pass through the center of the node counterclockwise, at an angle of **angleA**.

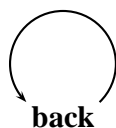

```
\node{A}{\bf back}
\nccircle[nodesep=3pt]{->}{A}{.7cm}
\kern 5pt
```

\nccircle can only connect a node to itself; it is the only node connection with this property. **\nccircle** is also special because it has an additional argument, for specifying the radius of the circle.

The last two node connections are also special. Rather than connecting the nodes with an open curve, they enclose the nodes in a box or curved box. You can think of them as variants of `\incline` and `\incarc`. In both cases, the half the width of the box is

boxsize=*dim*

Default: .4cm

You have to set this yourself to the right size, so that the nodes fit inside the box. The **boxsize** parameter actually sets the **boxheight** and **boxdepth** parameters. The ends of the boxes extend beyond the nodes by **nodesepA** and **nodesepB**.

`\ncbox*[par]{nodeA}{nodeB}`

`\ncbox` encloses the nodes in a box with straight sides. For example:

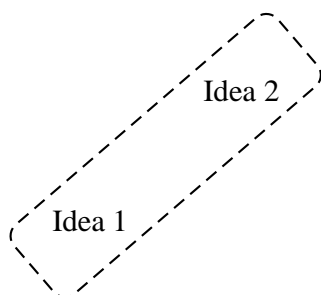

```
\rput[bl](.5,0){\node{A}{Idea 1}}
\rput[tr](3.5,2){\node{B}{Idea 2}}
\ncbox[nodesep=.5cm,boxsize=.6,linearc=.2,
linestyle=dashed]{A}{B}
```

`\incarcbox*[par]{nodeA}{nodeB}`

`\incarcbox` encloses the nodes in a curved box that is **arcangleA** away from the line connecting the two nodes.

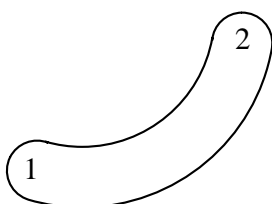

```
\rput[bl](.5,0){\node{A}{1}}
\rput[tr](3.5,2){\node{B}{2}}
\incarcbox[nodesep=.2cm,boxsize=.4,linearc=.4,
arcangle=50]{<->}{A}{B}
```

The arc is drawn counterclockwise from node A to node B.

There is one other node connection parameter that applies to all the node connections, except `\incarcbox`:

offset=*dim*

Default: 0pt

(You can also set **offsetA** and **offsetB** independently.) This shifts the point where the connection joins up by *dim* (given the convention that connections go from left to right).

There are two main uses for this parameter. First, it lets you make two parallel lines with **\ncline**, as in the following example:

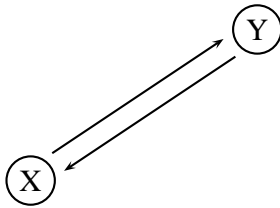

```
\ncnodeput(0,0){A}{X}
\nodeput(3,2){B}{Y}
\psset{nodesep=3pt,offset=4pt,arrows=->}
\ncline{A}{B}
\ncline{B}{A}
```

Second, it lets you join a node connection to a rectangular node at a right angle, without limiting yourself to positions that lie directly above, below, or to either side of the center of the node. This is useful, for example, if you are making several connections to the same node, as in the following example:

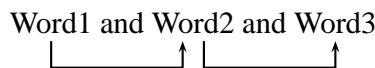

```
\rnode{A}{Word1} and \rnode{B}{Word2} and \rnode{C}{Word3}
\nlncbar[offsetB=4pt,angleA=-90,nodesep=3pt]{->}{A}{B}
\nlncbar[offsetA=4pt,angleA=-90,nodesep=3pt]{->}{B}{C}
```

Sometimes you might be aligning several nodes, such as in a tree, and you want to ends or the arms of the node connections to line up. This won't happen naturally if the nodes are of different size, as you can see in this example:

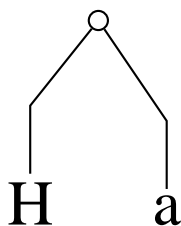

```
\Huge
\node(1,3){4pt}{a}
\rput[B](0,0){\Rnode{b}{H}}
\rput[B](2,0){\Rnode{c}{a}}
\psset{angleA=90,armA=1,nodesepA=3pt}
\nlncdiag{b}{a}
\nlncdiag{c}{a}
```

If you set the **nodesep** or **arm** parameter to a negative value, PSTricks will measure the distance to the beginning of the node connection or to the end of the arm relative to the center of the node, rather than relative to the boundary of the node or the beginning of the arm. Here is how we fix the previous example:

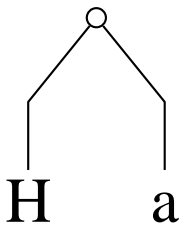

```

\Huge
\cnode(1,3){4pt}{a}
\lput[B](0,0){\Rnode{b}{H}}
\lput[B](2,0){\Rnode{c}{a}}
\psset{angleA=90,armA=1,nodesepA=-12pt}
\ncdiag{b}{a}
\ncdiag{c}{a}

```

Note also the use of **\Rnode**.

One more parameter trick: By using the **border** parameter, you can create the impression that one node connection passes over another.

The node connection commands make interesting drawing tools as well, as an alternative to **\psline** for connecting two points. There are variants of the node connection commands for this purpose. Each begins with **pc** (for “point connection”) rather than **nc**. E.g.,

```
\pcarc{<->}(3,4)(6,9)
```

gives the same result as

```

\pnode(3,4){A}
\pnode(6,9){B}
\pcarc{<->}{A}{B}

```

Only **\nccircle** does not have a **pc** variant:

<i>Command</i>	<i>Corresponds to:</i>
\pcline {arrows}(x1,y1)(x2,y2)	\cline
\pccurve {arrows}(x1,y1)(x2,y2)	\ncurve
\pcarc {arrows}(x1,y1)(x2,y2)	\ncarc
\pcbar {arrows}(x1,y1)(x2,y2)	\ncbar
\pcdiag {arrows}(x1,y1)(x2,y2)	\ncdiag
\pcangle {arrows}(x1,y1)(x2,y2)	\ncangle
\pcloop {arrows}(x1,y1)(x2,y2)	\ncloop
\pcbox (x1,y1)(x2,y2)	\ncbox
\pcarcbox (x1,y1)(x2,y2)	\ncarcbox

8 Node connections labels: I

Now we come to the commands for attaching labels to the node connections. The label command must come right after the node connection to

which the label is to be attached. You can attach more than one label to a node connection, and a label can include more nodes.

The node label commands must end up on the same \TeX page as the node connection to which the label corresponds.

There are two groups of connection labels, which differ in how they select the point on the node connection. In this section we describe the first group:

`\ncput*`*[par]{stuff}*

`\naput*`*[par]{stuff}*

`\nbput*`*[par]{stuff}*

These three command differ in where the labels end up with respect to the line:

`\ncput` *on* the line

`\naput` *above* the line

`\nbput` *below* the line

(using the convention that node connections go from left to right).

Here is an example:

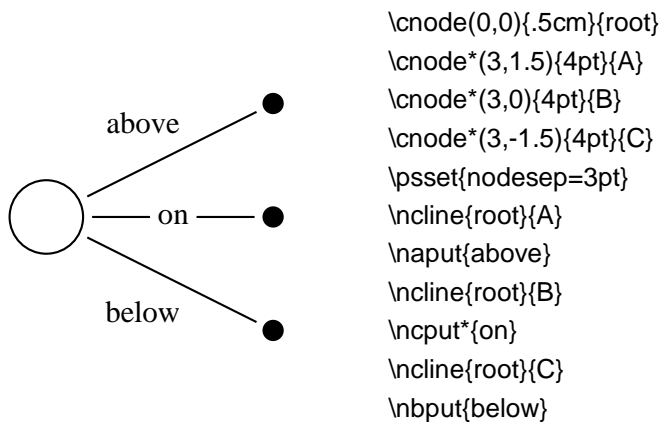

`\naput` and **`\nbput`** use the same algorithm as **`\ncput`** for displacing the labels, and the distance between the line and labels is **`labelsep`** (at least if the lines are straight).

`\ncput` uses the same system as **`\rput`** for setting the reference point. You change the reference point by setting the

`ref=ref`

Default: c

parameter.

Rotation is also controlled by a graphics parameter:

nrot=rot

Default: 0

rot can be in any of the forms suitable for `\rput`, and you can also use the form

`{:angle}`

The angle is then measured with respect to the node connection. E.g., if the angle is `{:U}`, then the label runs parallel to the node connection. Since the label can include other put commands, you really have a lot of control over the label position.

The next example illustrates the use `{:angle}`, the **offset** parameter, and `\pcline`:

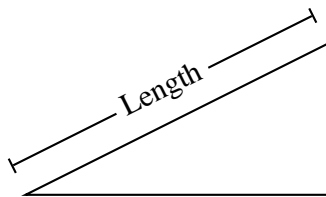

```
\pspolygon(0,0)(4,2)(4,0)
\pcline[offset=12pt]{|-|}(0,0)(4,2)
\ncput*[nrot=:U]{Length}
```

Here is a repeat of an earlier example, now using `{:angle}`:

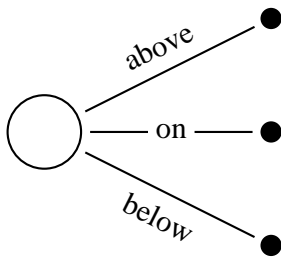

```
\cnode(0,0){.5cm}{root}
\cnode*(3,1.5){4pt}{A}
\cnode*(3,0){4pt}{B}
\cnode*(3,-1.5){4pt}{C}
\psset{nodesep=3pt,nrot=:U}
\ncline{root}{A}
\ncput{above}
\ncline{root}{B}
\ncput{on}
\ncline{root}{C}
\ncput{below}
```

The position on the node connection is set by the

npos=num

Default:

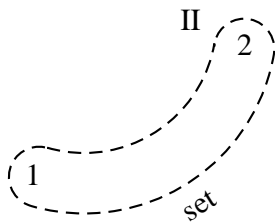

```

\put[bl](.5,0){\rnode{A}{1}}
\put[tr](3.5,2){\rnode{B}{2}}
\ncarcbox[nodesep=.2cm,boxsize=.4,linear=.4,
  arcangle=50,linestyle=dashed]{<->}{A}{B}
\nbput[nrot=:U]{set}
\nbput[npos=2]{II}

```

If you set the parameter

shortput=*none/nab/tablr/tab*

Default: none

to *nab*, then immediately following a node connection or another node connection label you can use \wedge instead of \wedge and $_$ instead of $_$.

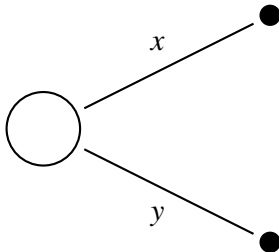

```

\cnode(0,0){.5cm}{root}
\cnode*(3,1.5){4pt}{A}
\cnode*(3,-1.5){4pt}{C}
\psset{nodesep=3pt,shortput=nab}
\ncline{root}{A}^{\$x\$}
\ncline{root}{C}_{\$y\$}

```

You can still have parameter changes with the short \wedge and $_$ forms. Another example is given on page 27.

If you have set **shortput=*nab***, and then you want to use a true \wedge or $_$ character right after a node connection, you must precede the \wedge or $_$ by $\{ \}$ so that PSTricks does not convert it to \wedge or $_$.

You can change the characters that you use for the short form with the

\wedge MakeShortNab{*char1*}{*char2*}

command.⁶

The **shortput=*tablr*** and **shortput=*tab*** options are described on pages 24 and ??, respectively.

9 Node connection labels: II

Now the second group of node connections:

⁶You can also use **\wedge MakeShortNab** if you want to use \wedge and $_$ with non-standard category codes. Just invoke the command after you have made your \wedge changes.

$\backslash\text{vput}^*[par]\{\text{stuff}\}$
 $\backslash\text{tlput}^*[par]\{\text{stuff}\}$
 $\backslash\text{trput}^*[par]\{\text{stuff}\}$
 $\backslash\text{thput}^*[par]\{\text{stuff}\}$
 $\backslash\text{taput}^*[par]\{\text{stuff}\}$
 $\backslash\text{tbput}^*[par]\{\text{stuff}\}$

The difference between these commands and the $\backslash\text{n}^*\text{put}$ commands is that these find the position as an intermediate point between the centers of the nodes, either in the horizontal or vertical direction. These are good for trees and mathematical diagrams, where it can sometimes be nice to have the labels be horizontally or vertically aligned. The t stands for “tree”.

You specify the position by setting the

$\text{tpos}=\text{num}$

Default: .5

parameter.

$\backslash\text{vput}$, $\backslash\text{tlput}$ and $\backslash\text{trput}$ find the position that lies fraction tpos in the *vertical* direction from the upper node to the lower node. $\backslash\text{thput}$, $\backslash\text{taput}$ and $\backslash\text{tbput}$ find the position that lies fraction tpos in the *horizontal* direction from the left node to the right node. Then the commands put the label on or next to the line, as follows:

<i>Command</i>	<i>Direction</i>	<i>Placement</i>
$\backslash\text{vput}$	vertical	middle
$\backslash\text{tlput}$	vertical	left
$\backslash\text{trput}$	vertical	right
$\backslash\text{thput}$	horizontal	middle
$\backslash\text{taput}$	horizontal	above
$\backslash\text{tbput}$	horizontal	below

Here is an example:

```

\
\setlength{\arraycolsep}{1.1cm}
\begin{array}{cc}
\Rnode{a}{(X-A)} & \Rnode{b}{A} \\
\Rnode{c}{x} & \Rnode{d}{\tilde{X}}
\end{array}

```

```

\psset{nodesep=5pt,arrows=->}
\everypsbox{\scriptstyle}
\inclin{a}{c}\tlput{r}
\inclin{a}{b}\taput{u}
\inclin[linestyle=dashed]{c}{d}\tbput{b}
\inclin{b}{d}\trput{s}
\]

```

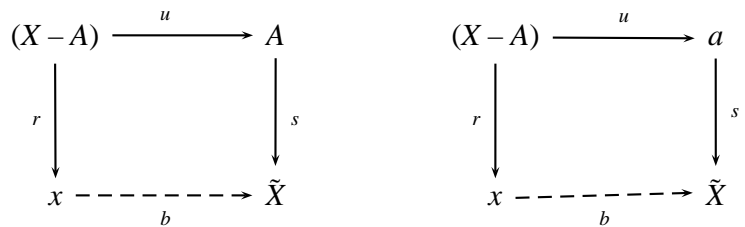

On the left is the diagram with `\tlput`, `\trput`, `\tbput` and `\Rnode`, as shown in the code. On the right is the same diagram, but with `\naput`, `\nbput` and `\Rnode`.

These do not have a rotation argument or parameter. However, you can rotate *stuff* in 90 degree increments using box rotations (e.g., `\rotateleft`).

If you set `shortput=tablr`, then you can use the following single-character abbreviations for the t put commands:

<i>Char.</i>	<i>Short for:</i>
^	<code>\taput</code>
_	<code>\tbput</code>
<	<code>\tlput</code>
>	<code>\trput</code>

You can change the character abbreviations with

`\MakeShortTablr{char1}{char2}{char3}{char4}`

The t put commands, including an example of `shortput=tablr`, will be shown further when we get to mathematical diagrams and trees.

Driver notes: The node macros use `\pstVerb` and `\pstverbscale`.

10 Attaching labels to nodes

The command

`\input*[par]{refangle}{name}{stuff}`

affixes *stuff* to node *name*. It is positioned distance **labelsep** from the node, in the direction *refangle* from the center of the node. The algorithm is the same as for `\lput`. If you want to rotate the node, set the

rot=rot

Default: 0

parameter, where *rot* is a rotation that would be valid for `\rput`.⁷ The position of the label also takes into account the **offsetA** parameter. If **labelsep** is negative, then the distance is from the center of the node rather than from the boundary, as with **nodesep**.

Here is how I used `\input` to mark an angle in a previous example:

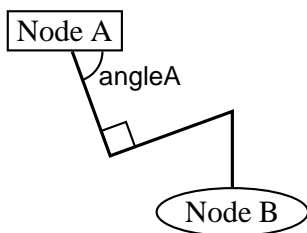

```
\rput[br](4,0){\ovalnode{B}{Node B}}
\rput[tl](0,3){\rnode{A}{\psframebox{Node A}}}
\input[labelsep=0]{-70}{A}{%
  \psarcn(0,0){.4cm}{0}{-70}
  \lput{.4cm}[-35](0,0){\tt angleA}}
\incangle[angleA=-70,angleB=90,armB=1cm,linewidth=1.2pt]{A}{B}
\ncput[nrot=:U,npos=1]{\psframe[dimen=middle](0,0){.35,.35}}
```

11 Mathematical diagrams and graphs

For some applications, such as mathematical diagrams and graphs, it is useful to arrange nodes on a grid. You can do this with alignment environments, such as \TeX 's `\halignprimitive`, \LaTeX 's `tabular` environment, and $\text{AMS-}\TeX$'s `matrix`, but `PSTricks` contains its own alignment environment that is especially adapted for this purpose:

`\psmatrix ... \endpsmatrix`

Here is an example

A			\$
			<code>\psmatrix[colsep=1cm,rowsep=1cm]</code>
			<code>& A \\\</code>
B	E	C	<code>B & E & C \\\</code>
			<code>& D &</code>
			<code>\endpsmatrix</code>
D			\$

⁷Not to be confused with the `nput` parameter.

As an alignment environment, `\psmatrix` is similar to AMS- \TeX 's `\matrix`. There is no argument for specifying the columns. Instead, you can just use as many columns as you need. The entries are horizontally centered. Rows are ended by `\`. `\psmatrix` can be used in or out of math mode.

Our first example wasn't very interesting, because we didn't make use of the nodes. Actually, each entry is a node. The name of the node in row *row* and column *col* is `{row,col}`, with no spaces. Let's see some node connections:

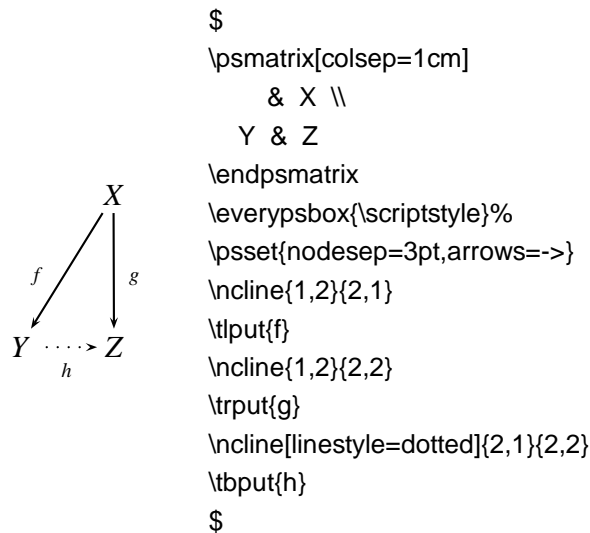

You can include the node connections inside the `\psmatrix`, in the last entry and right before `\endpsmatrix`. One advantage to doing this is that `shortput=tab` is the default within a `\psmatrix`.

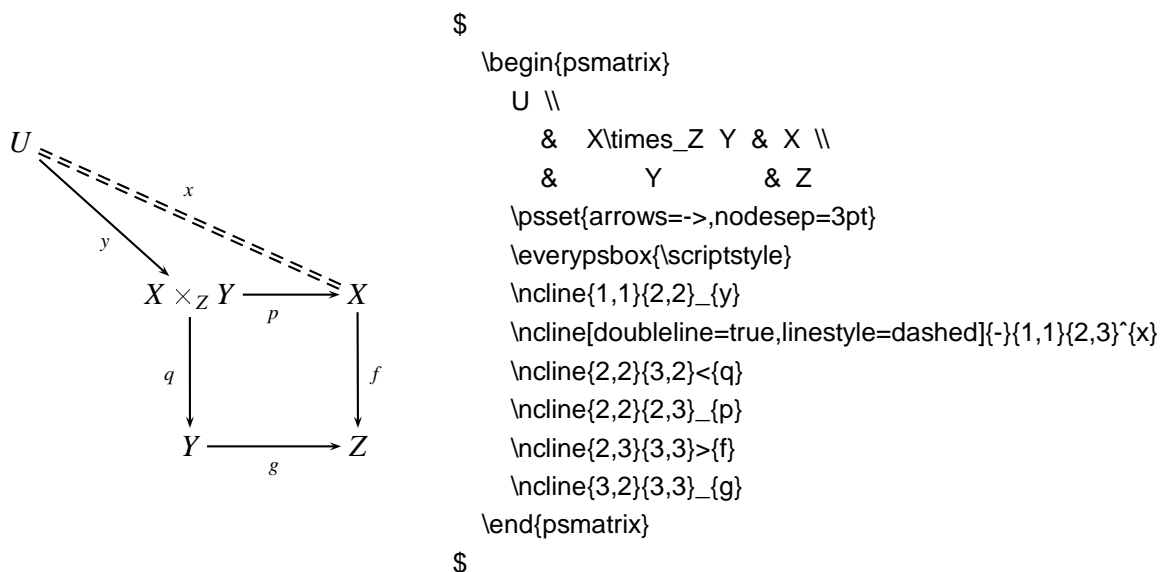

You can change the kind of nodes that are made by setting the

mnode=type

Default: R

parameter. Valid types are R, r, C, f, p, circle, oval, dia, tri, dot and none, standing for `\Rnode`, `\rnode`, `\Cnode`, `\fnode`, `\pnode`, `\circlednode`, `\ovalnode`, `\dotnode` and no node, respectively. Note that for circles, you use **mnode=C** and set the radius with the **radius** parameter.

For example:

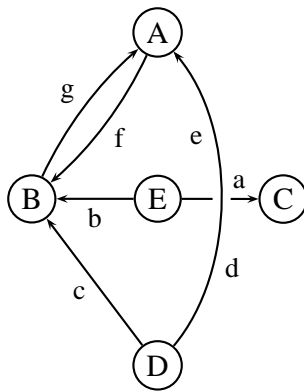

```
\psmatrix[mnode=circle,colsep=1]
  & A \\
  B & E & C \\
  & D & 
\endpsmatrix
\psset{shortput=nab,arrows=->,labelsep=3pt}
\small
\incline{2,2}{2,3}^[npos=.75]{a}
\incline{2,2}{2,1}^{b}
\incline{3,2}{2,1}^{c}
\incarc[arcangle=-40,border=3pt]{3,2}{1,2}
  _[npos=.3]{d}^[npos=.7]{e}
\incarc[arcangle=12]{1,2}{2,1}^{f}
\incarc[arcangle=12]{2,1}{1,2}^{g}
```

Note that a node is made only for the non-empty entries. You can also specify a node for the empty entries by setting the

emnode=type

Default: none

parameter.

You can change parameters for a single entry by starting with entry with the parameter changes, enclosed in square brackets. Note that the changes affect the way the node is made, but not contents of the entry (use `\psset` for this purpose). For example:

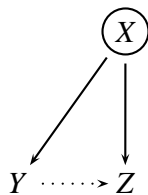

```

$
\psmatrix[colsep=1cm]
  & [mnode=circle] X \\
  Y & Z
\endpsmatrix
\psset{nodesep=3pt,arrows=->}
\incline{1,2}{2,1}
\incline{1,2}{2,2}
\incline[linestyle=dotted]{2,1}{2,2}
$

```

If you want your entry to begin with a `[` that is not meant to indicate parameter changes, the precede it by `{}`.

You can assign your own name to a node by setting the

`name=name`

Default:

parameter at the beginning of the entry, as described above. You can still refer to the node by `{row,col}`, but here are a few reasons for giving your own name to a node:

- The name may be easier to keep track of;
- Unlike the `{row,col}` names, the names you give remain valid even when you add extra rows or columns to your matrix.
- The names remain valid even when you start a new `\psmatrix` that reuses the `{row,col}` names.

Here a few more things you should know:

- The baselines of the nodes pass through the centers of the nodes. `\psmatrix` achieves this by setting the

`nodealign=true/false`

Default: false

parameter to true. You can also set this parameter outside of `\psmatrix` when you want this kind of alignment.

- You can left or right-justify the nodes by setting the

`mcol=l/r/c`

Default: c

parameter. l, r and c stand for left, right and center, respectively.

- The space between rows and columns is set by the

rowsep=*dim*
colsep=*dim*

Default: 1.5cm
Default: 1.5cm

parameters.

- If you want all the nodes to have a fixed width, set

mnodesize=*dim*

Default: -1pt

to a positive value.

- If `\psmatrix` is used in math mode, all the entries are set in math mode, but you can switch a single entry out of math mode by starting and ending the entry with `$`.
- The radius of the `c mnode` (corresponding to `\cnode`) is set by the

radius=*dim*

Default: 2pt

parameter.

- Like in \LaTeX , you can end a row with `\\[dim]` to insert an extra space *dim* between rows.
- The command `\psrowhookii` is executed, if defined, at the beginning of every entry in row *ii* (row 2), and the command `\pscolhookv` is executed at the beginning of every entry in column *v* (etc.). You can use these hooks, for example, to change the spacing between two columns, or to use a special **mnode** for all the entries in a particular row.
- An entry can itself be a node. You might do this if you want an entry to have two shapes.
- If you want an entry to stretch across several (*int*) columns, use the

`\psspan{int}`

at the end of the entry. This is like Plain \TeX 's `\multispan`, or \LaTeX 's `\multicolumn`, but the template for the current column (the first column that is spanned) is still used. If you want wipe out the template as well, use `\multispan{int}` *at the beginning of the entry* instead. If you just want to wipe out the template, use `\omit` before the entry.

- `\psmatrix` can be nested, but then all node connections and other references to the nodes in the `{row,col}` form for the nested matrix *must go inside* the `\psmatrix`. This is how PSTricks decides which matrix you are referring to. It is still neatest to put all the node connections towards the end; just be sure to put them before `\endpsmatrix`. Be careful also not to refer to a node until it actually appears. The whole matrix can itself go inside a node, and node connections can be made as usual. This is not the same as connecting nodes from two different `\psmatrix`'s. To do this, you must give the nodes names and refer to them by these names.

12 Obsolete put commands

This is old documentation, but these commands will continue to be supported.

There is also an obsolete command `\Lput` for putting labels next to node connections. The syntax is

```
\Lput{labelsep}[refpoint]{rotation}(pos){stuff}
```

It is a combination of `\Rput` and `\lput`, equivalent to

```
\lput(pos){\Rput{labelsep}[refpoint]{rotation}(0,0){stuff}}
```

`\Mput` is a short version of `\Lput` with no `{rotation}` or `(pos)` argument. `\Lput` and `\Mput` remain part of PSTricks only for backwards compatibility.

Here are the node label commands:

`\lput**[refpoint]{rotation}(pos){stuff}`

The `l` stands for “label”. Here is an example illustrating the use of the optional star and `:angle` with `\lput`, as well as the use of the `offset` parameter with `\pcline`:

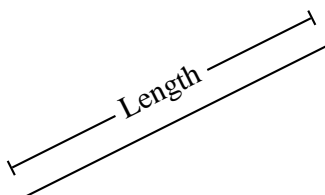

```
\pspolygon(0,0)(4,2)(4,0)
\pcline[offset=12pt]{-|}(0,0)(4,2)
\lput*{:U}{Length}
```

(Remember that with the put commands, you can omit the coordinate if you include the angle of rotation. You are likely to use this feature with the node label commands.)

With `\lput` and `\rput`, you have a lot of control over the position of the label. E.g.,

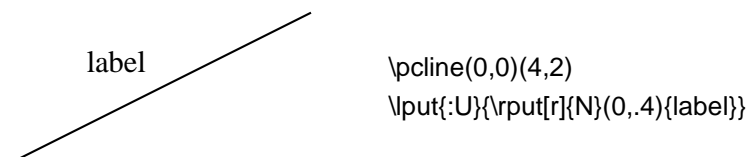

puts the label upright on the page, with right side located .4 centimeters “above” the position .5 of the node connection (above if the node connection points to the right). However, the `\lput` and `\bput` commands described below handle the most common cases without `\rput`.⁸

`\lput*[/labelsep]{angle}(pos){stuff}`

stuff is positioned distance `\pslabelsep` above the node connection, given the convention that node connections point to the right. `\lput` is a node-connection variant of `\lput`. For example:

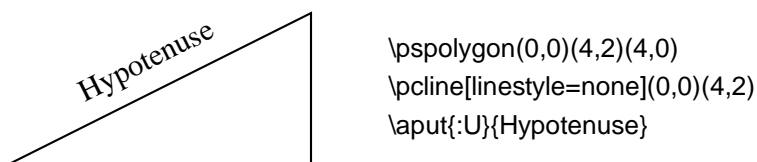

`\bput*[/labelsep]{angle}(pos){stuff}`

This is like `\lput`, but *stuff* is positioned below the node connection.

It is fairly common to want to use the default position and rotation with these node connections, but you have to include at least one of these arguments. Therefore, PSTricks contains some variants:

⁸There is also an obsolete command `\Lput` for putting labels next to node connections. The syntax is

```
\Lput[/labelsep][refpoint]{rotation}(pos){stuff}
```

It is a combination of `\Rput` and `\lput`, equivalent to

```
\lput(pos){\Rput[/labelsep][refpoint]{rotation}(0,0){stuff}}
```

`\Mput` is a short version of `\Lput` with no `{rotation}` or `(pos)` argument. `\Lput` and `\Mput` remain part of PSTricks only for backwards compatibility.

`\input*[refpoint]{stuff}`

`\Aput*[labelsep]{stuff}`

`\Bput*[labelsep]{stuff}`

of `\lput`, `\aput` and `\bput`, respectively, that have no angle or positioning argument. For example:

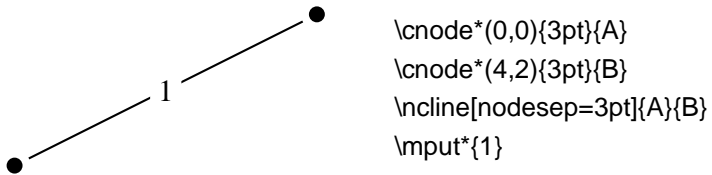

Here is another:

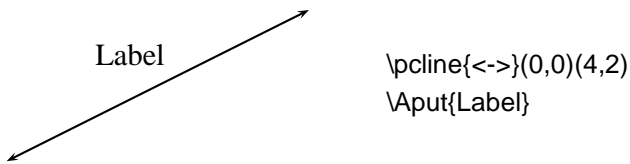

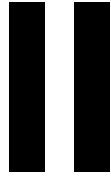

Trees

13 Overview



The node and node connections are perfect tools for making trees. The file `pstree.tex` / `pstree.sty` contains a high-level interface for positioning the nodes in a tree.

The main tree macro is

`\pstree{(root)node}{(sub)trees and (terminal)nodes}`

This positions the root node above its successors.

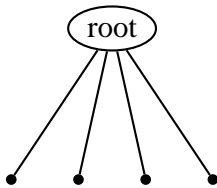

```
\pstree{\Toval{root}}{\TC* \TC* \TC* \TC*}
```

`\pstree` produces a box that encloses all the nodes, and whose baseline passes through the center of the root node.

For most of the nodes described in Section 6 (e.g., **`\ovalnode`**), there is a variant for use within a tree (e.g., **`\Toval`**). Note that there is no distinction between a terminal node and a root node, other than their position in the **`\pstree`** command.

A tree, when included in the list or successors, becomes a subtree.

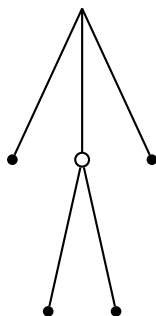

```
\pstree{\Tp}{%  
  \TC*  
  \pstree{\Tc{3pt}}{\TC* \TC*}  
  \TC*}
```

14 Tree Nodes

For most nodes described in Section 6, you can add strip node from the end of the name and add T add the beginning to obtain a node for use in trees. The syntax of a tree node is the same as of its corresponding “normal” node, except that:

- there is always an optional argument for setting graphics parameters, even if the original node did not have one,
- there is no argument for specifying the name of the node, and
- there is never a coordinate argument for positioning the node.
- to set the reference point with `\Tr`, set the **ref** parameter.

Here is the list of such tree nodes:

```

\Tp*[par]
\Tc*[par]{dim}
\TC*[par]
\Tf*[par]
\Tdot*[par]
\Tr*[par]{stuff}
\TR*[par]{stuff}
\Tcircle*[par]{stuff}
\Toval*[par]{stuff}
\Tdia*[par]{stuff}
\Ttri*[par]{stuff}

```

`\Rnode` is a good choice when you want the baselines of the text in the nodes to line up horizontally.

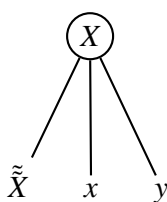

```

$
\pstree[nodesepB=3pt]{\Tcircle{X}}{%
  \TR{\tilde{\tilde{X}}}
  \TR{x}
  \TR{y}}
$

```

Compare the preceding example with the next one, which uses `\rnode`:

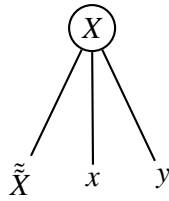

```

$
\pstree[nodesepB=3pt]{\Tcircle{X}}{%
  \Tr{\tilde{\tilde{X}}}
  \Tr{x}
  \Tr{y}}
$

```

There is also a null tree node

\Tn

It is meant to be just a place holder.

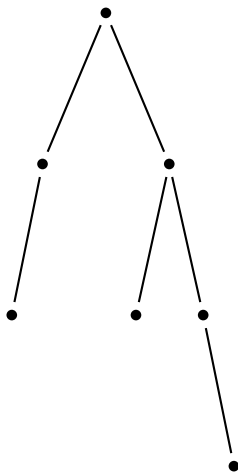

```

\pstree[nodesep=3pt]{\TC*}{%
  \pstree{\TC*}{\TC* \Tn}
  \pstree{\TC*}{%
    \TC*
    \pstree{\TC*}{\Tn\TC*}}}

```

Actually, if I was going to do this a lot I would define some short-cuts:

```

\def\mytree{\pstree{\TC*}}
\def\ltree#1{\mytree{#1\Tn}}
\def\rtree#1{\mytree{\Tn#1}}
\psset{nodesep=3pt}
\mytree{%
  \ltree{\TC*}
  \mytree{%
    \TC*
    \rtree{\TC*}}}

```

There is also a special tree node that doesn't have a "normal" version and that can't be used as the root node of a whole tree:

\Tfan*[par]

This draws a triangle whose base is

fansize=dim

Default: 1cm

and whose opposite corner is the predecessor node, adjusted by the value of **nodesepA** and **offsetA**. For example:

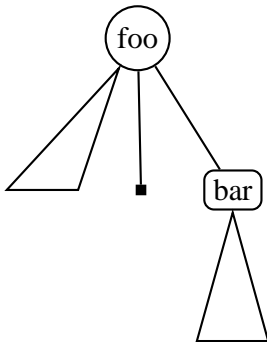

```
\pstree{\Tcircle{foo}}{%
  \Tfan
  \Tf*[framesize=4pt]
  \pstree{\Tr{\psframebox[framearc=.5]{bar}}}{\Tfan}}
```

Here is another example illustrating that a **Tfan** can have successors:

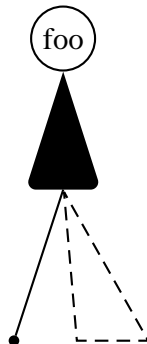

```
\pstree{\Tcircle{foo}}{%
  \pstree{\Tfan*[linear=.1]}{%
    \Tc*{2pt}
    \Tfan[linestyle=dashed]}}
```

15 Trees

This section describes several graphics parameters for **\pstree**. Any settings of graphics parameters for **\pstree** affects all of its successors, including subtrees. but not the root node.

The

treemode=R/L/U/D

Default:

parameter controls the direction in which the tree grows. R, L, U and D stand for “right”, “left”, “up” and “down”, respectively. When you change the **treemode**, the **treemode** of all nested trees changes as well.

For example, here is a tree that grows up, and then to the left:

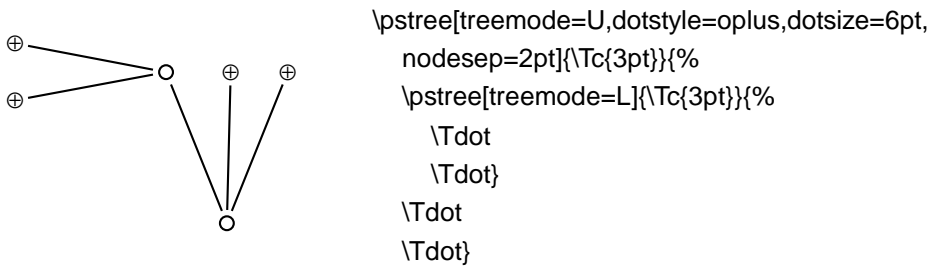

When the tree goes up or down, the successors are lined up from left to right in the order they appear in `\pstree`'s argument. When the tree goes left or right, the successors are lined up from top to bottom. As an afterthought, you might want to flip the order of the nodes. The

treeflip=true/false

Default: false

let's you do this.

A tree can also be root node. This is useful when the nested tree goes off in a different direction. If *treeB* is the root node of *treeA*, then the root of *treeB* is also the root node *treeA*.

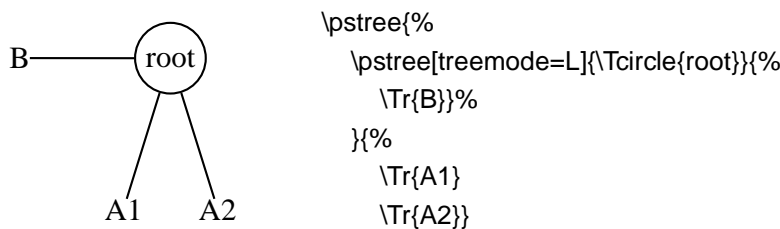

A node can also contain a tree, but that is another story.

The distance between successors and between levels is given by the

treeseq=dim
levelsep=*dim

Default: .75cm
Default: 2cm

parameters.

The distance between successors takes into account the size of the nodes, but the distance between levels does not, at least by default. If you include the optional `*` when setting **levelsep**, the level sep is in addition to the size of the nodes. However, PSTricks needs a second run through $\text{T}_{\text{E}}\text{X}$ (without any changes between runs) to get the spacing right, and it writes to the `.aux` file with $\text{L}_{\text{A}}\text{T}_{\text{E}}\text{X}$, and to the file `\jobname.pst` with other macro packages. (Even then, there is no guarantee it will get the spacing right.)

Here are two exaggerated examples that illustrates the difference between relative and absolute spacing between levels:

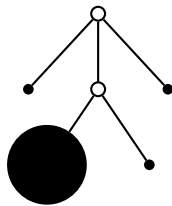

```
\pstree[levelsep=1cm,radius=2pt]{\Tc{3pt}}{%
  \TC*
  \pstree{\Tc{3pt}}{%
    \Tc*{15pt}
    \TC*}
  \TC*}
```

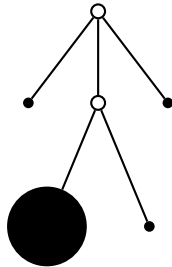

```
\psset{levelsep=*1cm,radius=2pt}
\pstree{\Tc{3pt}}{%
  \TC*
  \pstree{\Tc{3pt}}{%
    \Tc*{15pt}
    \TC*}
  \TC*}
```

If you set the

treenodesize=*dim*

Default: -1pt

to a non-negative value, then PSTricks uses **treenodesize** as a fixed size of the successors (in the direction of their neighbors, i.e., a fixed width for vertical trees and a fixed height/depth for horizontal trees). For example, sometimes it is esthetically pleasing to smooth over small variations in the sizes of the nodes. Compare

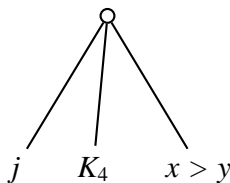

```
\pstree[nodesepB=-8pt]{\Tc{3pt}}{%
  \TR{<math>j</math>}%
  \TR{<math>K_4</math>}%
  \TR{<math>x > y</math>}}
```

with

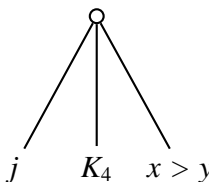

```
\pstree[treenodesize=.4cm,treesep=.3cm,nodesepB=-8pt]{\Tc{3pt}}{%
  \TR{<math>j</math>}%
  \TR{<math>K_4</math>}%
  \TR{<math>x > y</math>}}
```

A subtree's profile varies from level to level. **\pstree** has two modes for fitting subtrees together:

tight With tight fit, the subtrees are fit together so that the minimum distance on any level is **treesep**. This is the default.

loose With loose fit, the distance between the subtrees' bounding boxes is **treeseq**. Except when you have exceptionally large intermediate nodes, the effect is that the horizontal distance (or vertical distance, for horizontal trees) between all the terminal nodes is the same.

You select the mode with the

treefit=tight/loose

Default: tight

parameter.

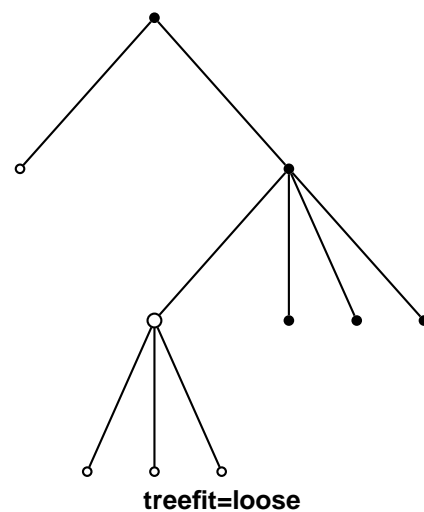
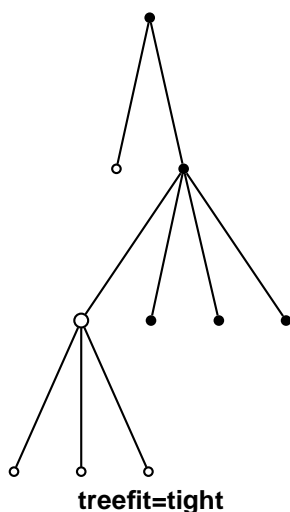

As noted at the beginning of this section, parameter changes made with **\pstree** affect all subtrees. However, there are variants of some of these parameters for making local changes, i.e., changes that affects only the current level:

thisreeseq=dim

Default:

thisreenodesize=dim

Default:

thisreefit=tight/loose

Default:

thislevelsep=*dim

Default:

For example:

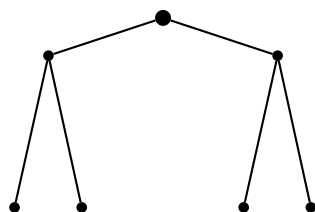

```
\pstree[thislevelsep=.5cm,thisreeseq=2cm,radius=2pt]{\TC*{3pt}}{%
  \pstree{\TC*}{\TC* \TC*}
  \pstree{\TC*}{\TC* \TC*}}
```

There are some things you may want set uniformly across a level in the tree, such as the **levelsep**. At level n , the command `\pstreehookroman(n)` (e.g., `\pstreehookii`) is executed, if it is defined (the root node of the whole tree is level 0, the successor tree objects and the node connections from the root node to these successors is level 1, etc.). In the following example, the **levelsep** is changed for level 2, without having to set the **thislevelsep** parameter for each of the three subtrees that make of level 2:

```

\
\def\pstreehookiii{\psset{thislevelsep=3cm}}
\pstree[treemode=R,levelsep=1cm,radius=2pt]{\Tc{4pt}}{%
  \pstree{\TC*}{%
    \pstree{\TC*}{\Tr{X_1} \Tr{X_2}}
    \pstree{\TC*}{\Tr{Y_1} \Tr{Y_2}}}
  \pstree{\TC*}{%
    \pstree{\TC*}{\Tr{K_1} \Tr{K_2}}
    \pstree{\TC*}{\Tr{J_1} \Tr{J_2}}}}
\

```

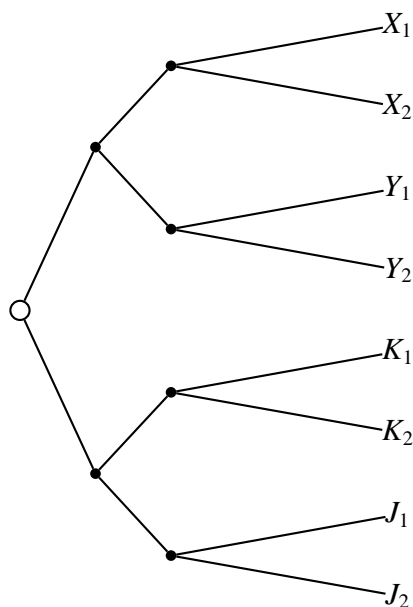

16 Edges

A tree node is really a composite object. In addition to creating a new node, it also draws a node connection between itself and its predecessor, if there is one.

When a tree node has made the new node, the command `\pssucc` is equal to the name of this node, and `\pspred` is equal to the name of its predecessor. Then the tree node executes

```
\psedge{\pspred}{\pssucc}
```

You can define `\psedge` to make whatever node connection you want (see Section ??). For example, here I use `\ncdiag`, with `armA=0`, to get all the node connections to emanate from the same point in the predecessor:

```
\def\psedge{\ncdiag[armA=0,angleB=180,armB=1cm]}
% Or: \renewcommand{\psedge}{ ... }
\pstree[treemode=R,levelsep=3.5cm,framesep=2pt]{\Tc{6pt}}{%
  \small \Tcircle{N} \Tcircle{K} \Tcircle{H} \Tcircle{L}}
```

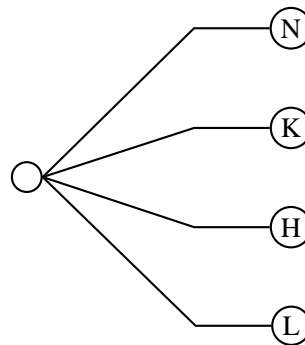

Here is another example with `\ncdiag`. Note the use of negative the `armA` value so that the corners of the edges are vertically aligned, even though the nodes have different sizes:

```
$
\def\psedge#1#2{\ncdiag[angleA=180, armA=-3cm,
  nodesep=4pt]{#2}{#1}}
% Or: \renewcommand{\psedge}[2]{ ... }
\pstree[treemode=R, levelsep=5cm]{\Tc{3pt}}{%
  \Tr{z_1\leq y}
  \Tr{z_1<y\leq z_2}
  \Tr{z_2<y\leq x}
  \Tr{x<y}}
$
```

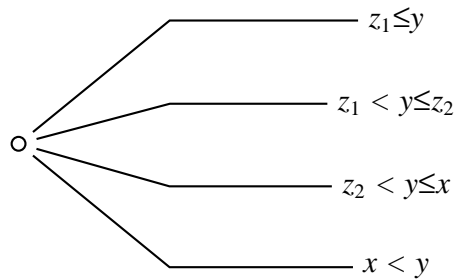

Another way to define `\psedge` is with the

edge=command

Default: \incline

parameter. Be sure to enclose the value in braces `{}` if it contains commas or other parameter delimiters. This gets messy if your command is long, and you can't use arguments like in the preceding example, but for simple changes it is useful. For example, if I want to switch between a few node connections frequently, I might define a command for each node connection, and then use the **edge** parameter.

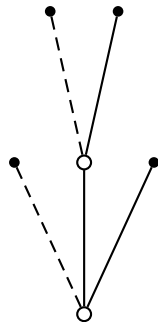

```
\def\dedge{\incline[linestyle=dashed]}
\pstree[treemode=U,radius=2pt]{\Tc{3pt}}{%
  \TC*[edge=\dedge]
  \pstree{\Tc{3pt}}{\TC*[edge=\dedge] \TC*}
  \TC*}
```

You can also set **edge=none** to suppress the node connection.

edge is the only parameter which, when set in a tree node's parameter argument, affects the drawing of the node connection (e.g., if you want to change the **nodesep**, your edge has to include the parameter change, or you have to set it before the node).

If you want to draw a node connection between two nodes that are not direct predecessor and successor, you have to give the nodes a name that you can refer to, using the **name** parameter. For example, here I connect two nodes on the same level:

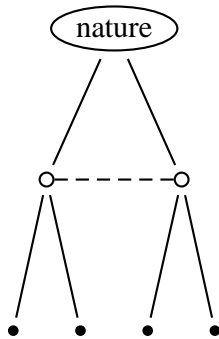

```
\pstree[nodesep=3pt,radius=2pt]{\Toval{nature}}{%
  \pstree{\Tc[name=top]{3pt}}{\TC* \TC*}
  \pstree{\Tc[name=bot]{3pt}}{\TC* \TC*}}
\incline[linestyle=dashed]{top}{bot}
```

We conclude with the more examples.

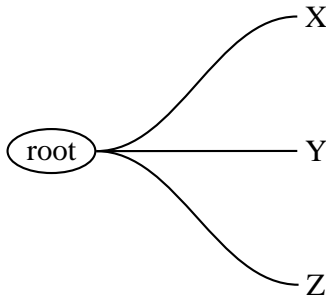

```
\def\psedge{\ncurve[angleB=180, nodesepB=3pt]}
\pstree[treemode=R, treesep=1.5, levelsep=3.5]%
{\Toval{root}}{\Tr{X} \Tr{Y} \Tr{Z}}
```

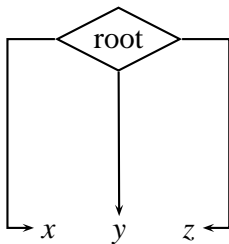

```
\pstree[nodesepB=3pt, arrows=->, xbb1=15pt,
  xbb2=15pt, levelsep=2.5cm]{\Tdia{root}}{%
  $
  \TR[edge=\ncbar[angle=180]]{x}
  \TR{y}
  \TR[edge=\ncbar]{z}
  $}
```

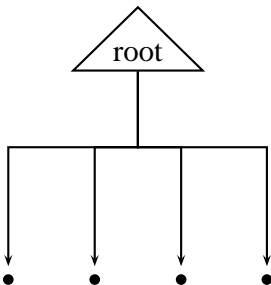

```
\psset{armB=1cm, levelsep=3cm, treesep=1cm,
  angleB=-90, angleA=90, arrows=<-, nodesepA=3pt}
\def\psedge#1#2{\ncangle{#2}{#1}}
\pstree[radius=2pt]{\Ttri{root}}{\TC* \TC* \TC* \TC*}
```

17 Edge and node labels

Right after a node, an edge has typically been drawn, and you can attach labels using `\ncput` `\lput`, etc.

With `\tlput`, `\trput`, `\taput` and `\tbput`, you can align the labels vertically or horizontally, just like the nodes. This can look nice, at least if the slopes of the node connections are not too different.

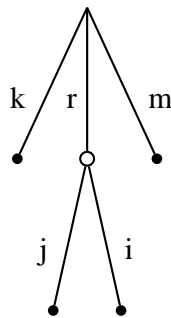

```
\pstree[radius=2pt]{\Tp}{%
  \psset{tpos=.6}
  \TC* \tlput{k}
  \pstree{\Tc{3pt} \tlput[labelsep=3pt]{r}}{%
    \TC* \tlput{j}
    \TC* \trput{i}}
  \TC* \trput{m}}
```

Within trees, the `tpos` parameter measures this distance from the predecessor to the successor, whatever the orientation of the tree. (Outside of trees it measures the distance from the top to bottom or left to right nodes.)

PSTricks also sets `shortput=tab` within trees. This is a special `shortput` option that should not be used outside of trees. It implements the following abbreviations, which depend of the orientation of the tree:

Short for:		
<i>Char.</i>	<i>Vert.</i>	<i>Horiz.</i>
^	<code>\tlput</code>	<code>\taput</code>
_	<code>\trput</code>	<code>\tbput</code>

(The scheme is reversed if `treeflip=true`.)

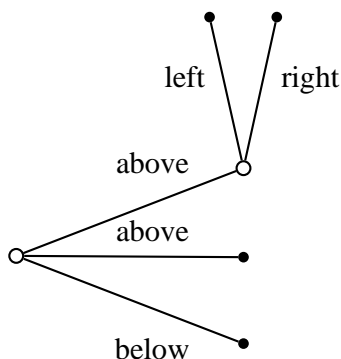

```
\psset{tpos=.6}
\pstree[treemode=R, thistreesep=1cm,
  thislevelsep=3cm,radius=2pt]{\Tc{3pt}}{%
  \pstree[treemode=U, xbb=20pt]{\Tc{3pt}^{above}}{%
    \TC*^{left}
    \TC*_{right}}
  \TC*^{above}
  \TC*_{below}}
```

You can change the character abbreviations with

`\MakeShortTab{char1}{char2}`

The `\n*put` commands can also give good results:

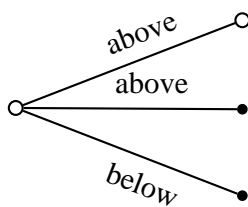

```
\psset{npos=.6,nrot=:U}
\pstree[treemode=R, thistreesep=1cm,
thislevelsep=3cm][\Tc{3pt}]{%
\Tc{3pt}\naput{above}
\Tc*{2pt}\naput{above}
\Tc*{2pt}\nbput{below}}
```

You can put labels on the nodes using `\nput`. However, `\pstree` won't take these labels into account when calculating the bounding boxes.

There is a special node label option for trees that does keep track of the bounding boxes:

`\nput[par]{stuff}`

Call this a “tree node label”.

Put a tree node label right after the node to which it applies, before any node connection labels (but node connection labels, including the short forms, can follow a tree node label). The label is positioned directly below the node in vertical trees, and similarly in other trees. For example:

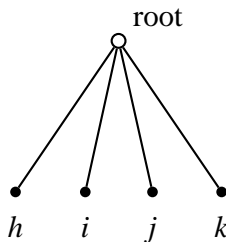

```
\pstree[radius=2pt][\Tc{3pt}\nput{45}{\pssucc}{root}]{
\TC*~{h$} \TC*~{i$} \TC*~{j$} \TC*~{k$}}
```

Note that there is no “long form” for this tree node label. However, you can change the single character used to delimit the label with

`\MakeShortTnput{char1}`

If you find it confusing to use a single character, you can also use a command sequence. E.g.,

`\MakeShortTnput{\tnput}`

You can have multiple labels, but each successive label is positioned relative to the bounding box that includes the previous labels. Thus, the order in which the labels are placed makes a difference, and not all combinations will produce satisfactory results.

You will probably find that the tree node label works well for terminal nodes, without your intervention. However, you can control the tree node labels by setting several parameters.

To position the label on any side of the node (left, right, above or below), set:

tnpos=l/r/a/b

Default:

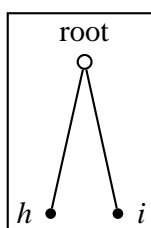

```
\psframebox{%
  \pstree{\Tc{3pt}~[tnpos=a,tndepth=0pt]{root}}{
    \TC*~[tnpos=l]{$h$}
    \TC*~[tnpos=r]{$i$}}
```

When you leave the argument empty, which is the default, PSTricks chooses the label position automatically.

To change the distance between the node and the label, set

tnsep=dim

Default:

When you leave the argument empty, which is the default, PSTricks uses the value of **labelsep**. When the value is negative, the distance is measured from the center of the node.

When labels are positioned below a node, the label is given a minimum height of

tnheight=dim

Default: $\ht\strutbox$

Thus, if you add labels to several nodes that are horizontally aligned, and if either these nodes have the same depth or **tnsep** is negative, and if the height of each of the labels is no more than **tnheight**, then the labels will also be aligned by their baselines. The default is $\ht\strutbox$, which in most \TeX formats is the height of a typical line of text in the current font. Note that the value of **tnheight** is not evaluated until it is used.

The positioning is similar for labels that go below a node. The label is given a minimum *depth* of

tndepth=*dim*

Default: `\dp\strutbox`

For labels positioned above or below, the horizontal reference point of the label, i.e., the point in the label directly above or below the center of the node, is set by the **href** parameter.

When labels are positioned on the left or right, the right or left edge of the label is positioned distance **tnsep** from the node. The vertical point that is aligned with the center of the node is set by

tnyref=*num*

Default:

When you leave this empty, **vref** is used instead. Recall that **vref** gives the vertical *distance* from the baseline. Otherwise, the **tnyref** parameter works like the **yref** parameter, giving the fraction of the distance from the bottom to the top of the label.

18 Details

Both `\pstree`'s root node argument and successors argument are processed as LR-boxes, and so everything in Appendix ??, including the treatment of math and verbatim text, applies, except the following. Because `\pstree` has two arguments, you cannot use `\pslongbox` to define a “long” version of `\pstree`. However, there is a variant `\psTree` of `\pstree` whose syntax is:

`\psTree{root node} successors \endpsTree`

For example:

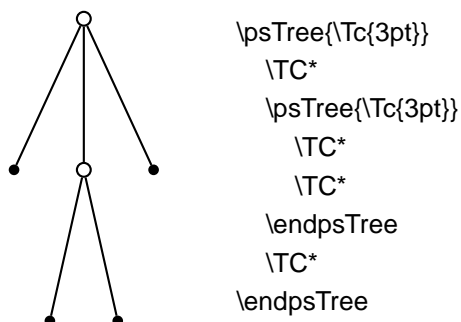

\LaTeX purists can write `\begin{psTree}` and `\end{psTree}` instead.

PSTricks does a pretty good job of positioning the nodes and creating a box whose size is close to the true bounding box of the tree. However,

PSTricks does not take into account the node connections or labels when calculating the bounding boxes, except the tree node labels.

If, for this or other reasons, you want to fine tune the bounding box of the nodes, you can set the following parameters:

bbl=dim	Default:
bbr=dim	Default:
bbh=dim	Default:
bbd=dim	Default:
xbbl=dim	Default:
xbbr=dim	Default:
xbbh=dim	Default:
xbbd=dim	Default:

The x versions increase the bounding box by *dim*, and the others set the bounding box to *dim*. There is one parameter for each direction from the center of the node, **left**, **right**, **height**, and **depth**.

These parameters affect trees and nodes, and subtrees that switch directions, but not subtrees that go in the same direction as their parent tree (such subtrees have a profile rather than a bounding box, and should be adjusted by changing the bounding boxes of the constituent nodes).

Save any fiddling with the bounding box until you are otherwise finished with the tree.

You can see the bounding boxes by setting the

showbbox=true/false **Default: false**

parameter to true. To see the bounding boxes of all the nodes in a tree, you have to set this parameter before the tree.

In the following example, the labels stick out of the bounding box:

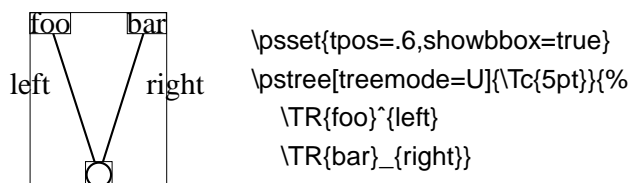

Here is how we fix it:

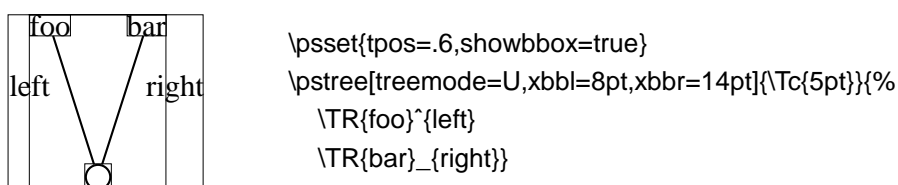

Now we can frame the tree:

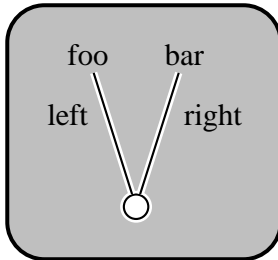

```
\psframebox[fillstyle=solid,fillcolor=lightgray,framesep=14pt,
lineararc=14pt,cornersize=absolute,linewidth=1.5pt]{%
\psset{tpos=.6,border=1pt,nodesepB=3pt}
\pstree[treemode=U,xdbl=8pt,xbbr=14pt]{%
\Tc[fillcolor=white,fillstyle=solid]{5pt}}{%
\TR*{foo}^{\left}
\TR*{bar}_{\right}}}
```

We would have gotten the same result by changing the bounding box of the two terminal nodes.

You can also adjust the distance between successors with the

\tspace{dim}

command.

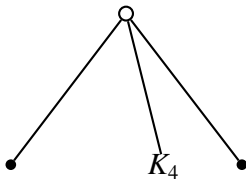

```
\pstree{\Tc{3pt}}{%
\Tc*{2pt}%
\tspace{1cm}
\TR*{$K_4$}%
\Tc*{2pt}}
```

To skip levels, use

\skipelevel*[par]{nodes or subtrees}

\skipelevels*[par]{int} nodes or subtrees \endskipelevels

These are kind of like subtrees, but with no root node.

```
\pstree[treemode=R,levelsep=1.8,radius=2pt]{\Tc{3pt}}{
\skipelevel{\Tfan}
\pstree{\Tc{3pt}}{
\TC*
\skipelevels{2}
\pstree{\Tc{3pt}}{\TC* \TC*}
\TC*
\endskipelevels
\pstree{\Tc{3pt}}{
\TC*
\TC*}}
```

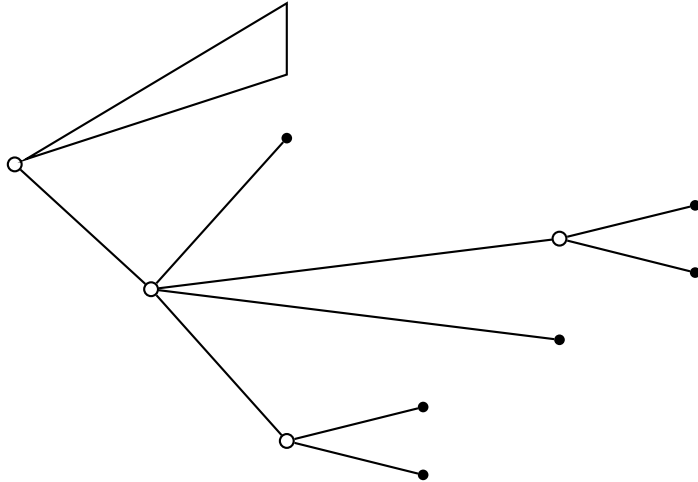

The profile at the missing levels is the same as at the first non-missing level. You can adjust this with the bounding box parameters. You get greatest control if you use nested `\skipelevel` commands instead of `\skipelevels`.

```

\large
\psset{radius=6pt, dotsize=4pt}
\pstree[thislevelsep=0,edge=none,levelsep=2.5cm]{\Tn}{%
  \pstree{\TR{Player 1}}{\pstree{\TR{Player 2}}{\TR{Player 3}}}
  \psset{edge=\ncline}
\pstree
  {\pstree[treemode=R]{\TC}{\Tdot ~{(0,0,0)} ^{N}}}{%
  \pstree{\TC[name=A] ^{L}}{%
    \Tdot ~{(-10,10.-10)} ^{I}
    \pstree{\TC[name=C] _{r}}{%
      \Tdot ~{(3,8,-4)} ^{c}
      \Tdot ~{(-8,3,4)} _{d}}
    \pstree{\TC[name=B] _{R}}{%
      \Tdot ~{(10,-10.0)} ^{I}
      \pstree{\TC[name=D] _{r}}{%
        \Tdot ~{(4,8,-3)} ^{c}
        \Tdot ~{(0,-5,0)} _{d}}
      }}
  \ncbox[linear=.3,boxsize=.3,linestyle=dashed,nodesep=.4]{A}{B}
  \ncarcbox[linear=.3,boxsize=.3,linestyle=dashed,
    arcangle=25,nodesep=.4]{D}{C}

```

